



Periphery components for ESSER FACP

GB Technical Information

798960.GB0

04.2020

Intended purpose

This products may be used only for the applications outlined in the catalogue and in the technical description, and only in conjunction with the recommended and approved external devices and components.

This documentation contains registered and unregistered trademarks. All trademarks are the property of the respective owners. The use of this documentation does not grant you a licence or any other right to use any name, logo or label referred to or depicted herein.

This documentation is subject to the copyright of Honeywell. The content must not be copied, published, modified, distributed, transmitted, sold or changed without the express prior written permission of Honeywell. The information contained in this documentation is provided without warranty.

Safety-related user information

This manual includes information required for the proper use of the products described.

In order to ensure correct and safe operation of the product, all guidelines concerning its transport, storage, installation, and mounting must be observed. This includes the necessary care in operating the product.

The term 'qualified personnel' in the context of the safety information included in this manual or on the product itself designates:

- project engineers who are familiar with the safety guidelines concerning fire alarm and extinguishing systems.
- trained service engineers who are familiar with the components of fire alarm and extinguishing systems and the information on their operation as included in this manual.
- trained installation or service personnel with the necessary qualification for carrying out repairs on fire alarm and extinguishing systems or who are authorised to operate, ground and label electrical circuits and/or safety equipment/systems.

Symbols

The following information is given in the interest of personal safety and to prevent damage to the product described in this manual and all equipment connected to it.

Safety information and warnings for the prevention of dangers putting at risk the life and health of user and maintenance personnel as well as causing damage to the equipment itself are marked by the following pictograms. Within the context of this manual, these pictograms have the following meanings:



Warning - Designates risks for man and/or machine. Non-compliance will create risks to man and/or machine. The level of risk is indicated by the word of warning.



Note - Important information on a topic or a procedure and other important information.



Standards and guidelines - Observe configuration and commissioning information in accordance to the national and local requirements.

Dismantling



In accordance with Directive 2012/19/EU (WEEE), after being dismantled, electrical and electronic equipment is taken back by the manufacturer for proper disposal.

© Honeywell International Inc./technical changes reserved!

This documentation is subject to copyright law and, as per Sections 16 and 17 of the German Copyright Act (UrhG), is neither permitted to be copied nor disseminated in any other way. Any infringement as per Section 106 of the UrhG may result in legal action.

Table of contents

1	General / Application.....	4
2	Standards and guidelines.....	5
3	Planning and development.....	7
3.1	Alarm identification.....	7
4	Maintenance.....	8
4.1	Maintenance.....	9
4.2	Inspection.....	10
5	Automatic point-type fire detectors.....	12
5.1	Series IQ8Quad fire detectors.....	12
5.2	IQ8Quad Ex (i) fire detectors for use in ex-areas.....	15
5.3	Fire detectors series IQ8Quad with integrated alarm device.....	17
5.4	Fire Detectors series ES Detect.....	21
5.5	Detector base and options.....	24
5.6	Arrangement of point-type fire detectors.....	30
6	Manual call point (MCP).....	31
6.1	Manual call point - large design (plastic).....	31
6.2	Manual call points - large design (aluminium Die-Cast Housings).....	34
6.3	Manual Call Point – large design (accessories).....	36
6.4	Manual call point - small design.....	37
6.5	Manual call point - small design (accessories).....	39
6.6	Manual Call Points special design.....	40
6.7	Configuration of manual call points (MCP).....	43
7	IQ8Wireless – Wireless Components and accessories.....	44
7.1	IQ8Wireless transponder.....	47
7.2	IQ8Wireless gateway.....	50
7.3	IQ8Wireless detector base.....	53
8	Planning of IQ8Wireless components.....	55
8.1	Planning information.....	55
8.2	System requirements.....	56
8.3	Batteries for IQ8Wireless devices.....	56
9	Alarm devices.....	57
9.1	Alarm device IQ8Alarm Plus.....	57
9.2	Conventional alarm device.....	61
10	Development of audible alarm devices.....	62
10.1	Requirements.....	65
10.2	Project planning information.....	65
10.3	Commissioning.....	68
10.4	Creating a signal template.....	70
11	Maximum cable length and load factor.....	76
12	esserbus® transponder.....	78
12.1	esserbus® alarm transponder (Part No. 808623).....	79
12.2	esserbus® transponder for UniVario (Part No. 808623.10).....	80
12.3	esserbus® transponder Special detector (SD) (Part No. 808623.40).....	81
12.4	esserbus® transponder 12 relays (Part No. 808610.10).....	82
12.5	esserbus® transponder 32 LED (Part No.808611.10).....	83
12.6	esserbus® transponder SIE (Part No. 808613.30).....	84
12.7	esserbus® transponder IQ8FCT XS (Part No. 808606).....	85
12.8	esserbus® transponder IQ8FCT LP, 230 V AC (Part No. 808621).....	86
12.9	Technical Alarm Module IQ8TAL (Part No. 804868).....	87
12.10	IQ8FCT (Part No. 804867).....	88

**Additional and updated Informations**

The described features, specifications and product related informations in this manual correspond to the date of issue (refer to date on the front page) and may differ due to modifications and/or amended Standards and Regulations of the System design, Installation and Commissioning.

Updated informations and declaration of conformity are available for comparison on the www.esser-systems.com homepage.

esserbus® and essernet® are registered trademarks in Germany.

1 General / Application

This Technical Information provides an overview of the peripheral components that can be connected and used as integral parts of ESSER fire alarm systems:

- automatic fire detectors
- manual call points
- esserbus® transponders
- wireless components
- alarm devices

These components must be considered as important components of the fire alarm system during planning, commissioning and maintenance.

The information and technical specifications detailed in this documentation are designed to give an experienced engineer a basis for planning and to enable a fire alarm specialist to carry out quick installation and precise maintenance.

Relevant knowledge and qualifications are required.

In order to carry out work properly and safely, compliance with all specified safety and operating information in this documentation is required, as well as a correctly planned fire alarm system (FAS) that conforms to the applicable standards and guidelines.

Furthermore, object-specific design and planning documents for the FAS and local requirements must be observed.

Other documents relevant for planning, commissioning and maintenance are listed in the following table. Important information can also be found in the documentation for the components used.

Associated Documents

Part No.	Description
798654.GB0	Technical Information Manufacturer's instruction for the commissioning and maintenance of fire alarm systems
798920.EU.EN	Technical Information Obligatory Information for Ex (i) devices
798961.GB0	Technical Information Third party detector for ESSER-Fire Alarm Panel

FAS installer

Installers are a qualified electrician who, due to their professional training, are adequately qualified to install fire alarm systems and are also familiar with the requirements of hazard alarm systems and telecommunications. The FAS installer installing this system understands and implements the planning and project specifications for this fire alarm system and assesses the implementation of the individual work steps and recognises potential hazards.

System operator / trained person

A 'trained person' is an individual that has been trained in the performance of the operations required to operate a fire alarm system (FAS) or hazard alarm system (HAS). This training must have been provided by a specialist. The trained person must be able to independently operate the system's basic functions, able to ascertain that the system is working properly, and initiate remedial action in case of irregularities or defects.

Service and programming software tools 8000

The commissioning and configuration of the fire alarm system requires the use of the tools 8000 service and programming software, version V1.16 or higher.

2 Standards and guidelines

When fire alarm systems are being installed and operated, the applicable standards and guidelines as well as the generally accepted technological standards must be complied with. Any deviation from those rules is only admissible if the same degree of safety can be ensured with different means. Installations within the European Community are primarily subject to all EU regulations defining the current standards for security systems.

In Germany, systems are considered to be in compliance with the general technical rules or the standards of the EU for security systems if they meet the technical guidelines of the VDE (Verband Deutscher Elektrotechniker, Association of German Electrical Engineers). They may also be considered to be in compliance with the standards of the EU for security systems if they meet the technical guidelines of another comparable institution within the European Community which have been accepted in accordance with directive on low-voltage systems. The same must be applied for all applications of additional, product relating guidelines, e.g. EMI-Guideline and the Construction Products Regulation.

Examples of the standards – excerpt (not necessarily exhaustive):

- Standards of the DIN EN 54 “Fire alarm systems“, particularly DIN EN 54-2 „Fire alarm control panels“ and DIN EN 54-4 „Power supply units“.
- Standards of the DIN VDE 0100 issue, particularly DIN EN 0100-410 „Installation of high-voltage systems with rated voltage up to 1000 V“, DIN VDE 100-718, Install low voltage systems – Requirements for sites, rooms and special systems and DIN VDE 0105-100 „Operation of electrical system: General commitments“.
- Standards of the DIN EN 62305 or DIN VDE 0185-305 issue, particularly DIN VDE 0185-305-1 „Lightning protection: General standards. DIN VDE 0185-305-2 „Risk-Management“, DIN VDE 0185-305-3 „Protection of buildings and persons“ and DIN VDE 0185-305-4 „Electrical and electronic systems in buildings“.
- DIN VDE 0701-1 „Maintenance, Modification and Test of electrical devices: General commitments“.
- Standards of the DIN VDE 0800 issue, particularly DIN VDE 0800-2 „General commitments, Requirements and Tests for system security“, DIN VDE 0800-1 „Communication systems, Earthing and potential compensation“, DIN VDE 0800-174-2 “Information systems – design and installation of communication cabling in buildings“.
- DIN VDE 0815 „Cables for communication and information systems“.
- Standards of the DIN VDE 0833 issue Hazard alarm systems for Fire, Intruder and Hold-up, particularly DIN VDE 0833-1 „General commitments“, DIN VDE 0833-2 „Commitments for fire alarm systems (FAS)“, DIN VDE 0833-3 „Commitments for Intruder and Hold-up systems“ and DIN VDE 0833-4 „Commitments for Voice alarm systems within fire protection“.
- Standards of the DIN VDE 0845 issue, particularly DIN VDE 0845-1 „Protection of Communication systems against Lightning, electrostatic charge and overvoltage from high-voltage systems; Actions to avoid over-voltage“.
- DIN 14675 Fire alarm systems - mounting and operation.



Within the EU, these standards and guidelines and the technological standards must be complied with.

Depending on the place of use, national/regional requirements of certain organisations (e.g. local fire brigades and competent authorities) must also be observed.

In other/non-European countries (e.g. USA: NFPA and UL requirements), country-specific standards, guidelines and laws must be complied with.

In addition, even more stringent requirements apply in Germany, for example, such as the guidelines of VdS Schadenverhütung GmbH (VdS):

- VdS 2046 Safety rules for electrical power systems with voltages up to 1000 V.
- VdS 2015 Electrical appliances and systems – rules for damage prevention.
- VdS 2095 Design and installation of fire alarm systems.
- VdS 2833 Overvoltage protection measures for Hazard Alarm Systems.
- Observe national and local building law requirements and regulations (building regulations).
- Fire brigade guidelines
- Building regulations
- Garage regulations
- Hospital regulations
- Office regulations
- Multi-storey building regulations
- Meeting room regulations
- Technical connection conditions

In addition:

- DIN EN 54-20 Aspirating smoke detectors
- DIN EN 54-23 Visual alarm devices
- National and local special building regulations (e.g. for garages, hospitals, schools, places of assembly, industrial buildings)



- In principle, the standards and guidelines outlined in this documentation refer to the current version as amended.
- For specific ATEX-relevant standards and guidelines, see Technical Information 798920.EU.xx.

DIN VDE (German Association for Electrical, Electronic & Information Technologies)

VdS (German Association of Loss Insurers)

DIBt (German Institute for Civil Engineering) guidelines

3 Planning and development

A fire alarm system (FAS) is made up of one or more fire alarm control panel(s) as well as automatic fire detectors and manual call points, components (such as esserbus® transponders) and alarm devices. In addition, object-specific wireless components or detectors for special applications may be required.

The individual sections provide information about the various components and devices, their areas of use and possible planning.

In addition, the standards and guidelines listed in Section 2 and the information and technical specifications in this documentation provide a good basis for planning and designing a FAS.

3.1 Alarm identification

The automatic detectors must be labelled with the detector zone and detector number according to DIN 1450. This information is also displayed (often with additional text) in the displays of the FACP and operating panels.

In addition, in consideration of the local (fire brigade) requirements, automatic detectors may also be equipped with the optional label plate (Part No. 805576). The label plate is secured in the side opening of the detector base before or even after installation.



- Reading distance (m): 3 = font size in cm
- Use up to maximum 3 m ceiling height.
- For more information, see the Fire Alarm Technology product group catalogue.

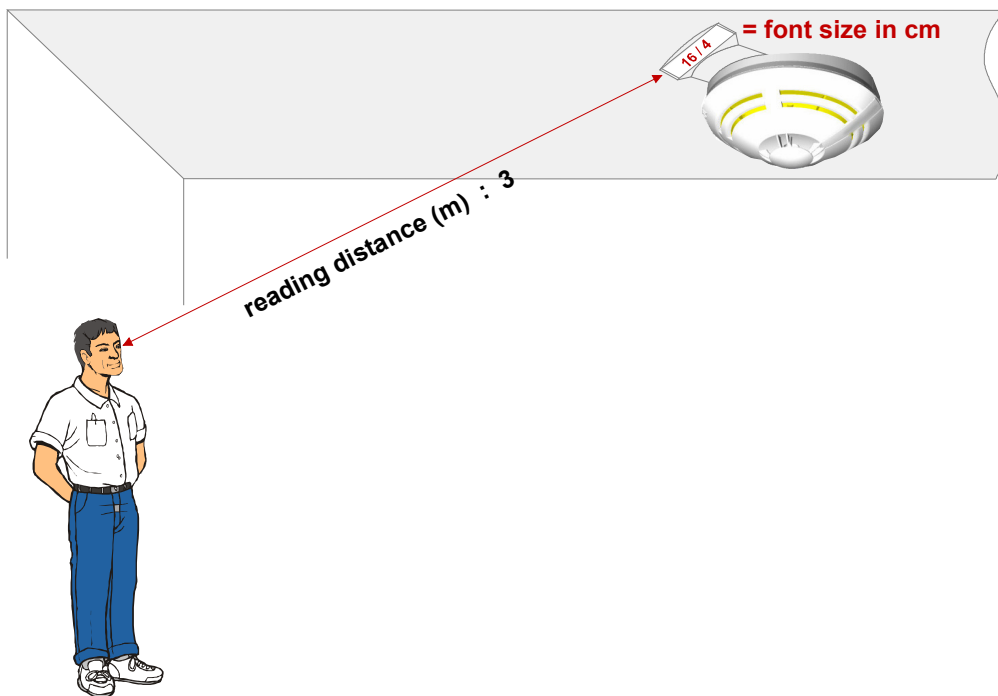

Fig. 1: Alarm identification with automatic fire detector

Manual call points and alarm devices can be directly provided with an appropriately labelled and easily legible sticker. In this case, observe the local requirements too!

4 Maintenance

Devices like automatic fire detectors, manual call points / MCP, alarm devices and transponders are manufactured, configured and delivered as per the applicable standards and guidelines. Over time, use in different ambient conditions can lead to the accumulation of dirt on the detector sensors of automatic fire detectors due to air pollution such as aerosols, grease, dust etc.

For this reason, to ensure fire detectors are always ready for operation, it is necessary for them to be tested and serviced on a regular basis (see DIN VDE 0833-1).



- Before a fire detector is removed from the detector zone for servicing, it should be disconnected from the fire alarm control panel.
- In addition, note down the installation location and serial number.
- A detector zone that is disconnected/in test mode cannot raise an alarm in case of an event!

Fire alarm systems must be tested regularly by fire alarm specialists. The details of such tests and all actions to be carried out can be found in standard DIN VDE 0833-1 and VdS guideline 2095. In addition, other accompanying standards (e.g. DIN 14675) must be complied with when fire alarm systems are serviced. Servicing includes all actions on the protection and restoration of the nominal conditions and on the identification and assessment of the actual status of the technical modules of a system.

Structure of maintenance process

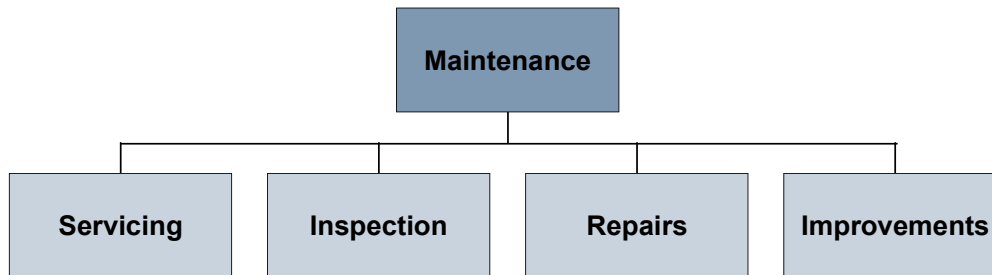

In addition, DIN 14675 provides information about requirements for maintenance with notes referring to various detection measures and detector technologies.

However, detailed test instructions are not given. Therefore, the manufacturer has a duty to formulate relevant instructions or to make compliant test equipment available.

For further informations refer to technical Information (Part No. 798654.GB0).

Depending on the technology used, fire alarms such as standard detectors can be equipped as detectors with decentralized or centralized intelligence.

Through distributed intelligence, a detector can monitor its own specific values that correspond to the reference values with adjusted response to an authorization value in accordance with EN 54.

By compensating reference values based on analytical self-monitoring, such intelligent fire alarms can give readings that can be read and visualized with the service and programming software tools 8000. On the basis of stored specific comparative values, this software can assess whether cleaning or replacement of the fire alarm is required.

With standard detectors or fire detectors without analytical self-monitoring, a maintenance engineer will have no choice but to act upon the fire alarm with the fire parameter being monitored, that is expected in the course of the fire according to the fire loads. This criterion (smoke, heat, gas) should be recognized by the fire detector to be tested in a given time, which is to be evaluated as a confirmation function of the detector.

Contaminated standard detectors usually display a greater insensitivity, meaning that the detection time of a contaminated fire detector is considerably extended. These fire detectors can usually be cleaned, but it is not possible to provide proof of regaining functionality according to EN 54.

Therefore, it is generally recommended that contaminated standard detectors be replaced.

When checking the actual status during maintenance, it is important to ensure that the correct criterion is applied so that the fire alarm is tested according to its project planning and approval. Multi-criteria detectors of the series IQ8Quad and ES Detect are authorized as smoke and heat detectors according to EN 54-5 and -7, but in most cases as a smoke detector, there is additional monitoring of temperature increases.

Among other things, the maximum monitoring area of a fire detector to be calculated depending on the installation height is derived from this. If the detector has been planned for smouldering fire development with heavy smoke formation, this must also be triggered annually with the test gas approved by the manufacturer.

Multi-criteria detectors that monitor a poorly predictable course of the fire should be, if necessary, acted upon annually with heat and test gas with carbon monoxide to ensure broadband functionality and detection readiness in case of emergency.

Fire Detectors of the IQ8Quad & ES Detect Series

- Smoke detector:** Trigger once a year with test gas and wait until the individual display of the detector shows activation confirmation.
- Heat Detector:** Warm with the heat detector test head or a hairdryer once a year (not a heat gun) until the individual display of the detector confirms its activation.
- Multi-criteria-detector:** Trigger once a year with test gas and wait until the individual display of the detector shows activation confirmation. For the projected monitoring of several fire parameters, all criteria should be tested with the corresponding test values.

All fire alarms of the IQ8Quad series should be cyclically inspected (inspection interval) with the service and programming software tools 8000 in order to evaluate with technical measurements the degree of contamination of sensors and the corresponding compensation of the reference values.



- The tools 8000 service and programming software provides support with commissioning, maintenance and servicing.
- The automatic fire detectors must be serviced exclusively using approved testing devices for smoke and heat detectors.
- The esserbus[®] test and configuration tool (Part No. POL-ESS TOUCH) can also be used to configure cable networks or esserbus[®] or esserbus[®]-PLus loops and to check for errors or faults without a FACP if required.
- Further information see the product group catalogue, the documentation of the devices used and the Technical Information (Part No. 798654.GB0).

4.1 Maintenance

Maintenance work must be carried out at least once a year, according to manufacturer instructions. All actions for the protection of the target conditions of the technical modules of a system are to be implemented. The place of installation/the ambient conditions and level of contamination of the fire detectors should be assessed.

4.2 Inspection

Inspections should be conducted at least four times a year at equally-spaced intervals, during which all steps for identifying and assessing the actual status of the technical modules of a system should be carried out. The recording range and/or accessibility of the fire detectors should also be checked visually.

The following should be inspected for correct functions:

- The primary loop, of which at least one detector must be tested via activation, but when checking automatic detectors only non-destructive testable devices.
- All non-destructive testable fire detectors must be activated at least once a year.
- At least once a year, even on destructive testable detectors.



If unauthorised deviation from the nominal conditions is confirmed during the inspection of a fire alarm system, repairs should be carried out immediately. Yearly maintenance and quarterly inspections should be incorporated into a maintenance programme.

Inspection

	Work to be carried out	Information
Preparations	In order to avoid a false alarm, notify the appropriate emergency services. Disconnect fire brigade master box (MB) und external activation.	Make known the type and duration of the work.
	Visual check: Check fire detector for possible damage and, if necessary, replace.	Only replace fire detectors with detectors of the same type.
Testing	Operational FACP must be in normal status.	----
	Always trigger with the recommended test device one automatic fire detector in each primary loop.	Only use the approved test device/test gas for triggering follow operating instructions! It may take several seconds for the LED on the fire detector to light up. Do not trigger more than 5 detectors per zones at any one time.
	No display: Defective/non-operational fire detector.	Check defective/non-triggered detectors and if necessary clean and/or replace.
Commissioning	Install checked/cleaned or replaced fire detectors and re-trigger.	----
	Reset the fire detectors that have been tested and triggered to normal operation mode by switching on the detector zone again.	Fire detectors can only be reset in smoke-free, or in the case of heat sensors, cool, environments.
	Ensure that there is no alarm on the FACP. Switch on fire brigade master box und external activation.	----
	Inform the appropriate emergency services of the completion of the work.	Entry in the operating manual of the FACP.

Inspection on the fire alarm control panel

	Work to be carried out	Information
Preparations	In order to avoid a false alarm, notify the appropriate emergency services. Disconnect fire brigade master box (MB) und external activation.	Make known the type and duration of the work.
	Visual check: Check fire detector for possible damage and, if necessary, replace.	Only replace fire detectors with detectors of the same type.
	Detector replacement: After the replacement of a detector the detector data must be re-programmed.	Programming of the detector in the installer mode of the FACP.
Testing	Switch on the loop for initialisation again.	----
	Always trigger with the recommended test device one automatic fire detector in each primary loop.	Only use the approved test device/test gas for triggering – follow operating instructions! It may take several seconds for the LED on the fire detector to light up. Do not trigger more than 5 detectors per zones at any one time.
	No display: Defective/non-operational fire detector.	Check defective/non-triggered detectors and if necessary clean and/or replace.
	Install checked/cleaned or replaced fire detectors and re-trigger.	----
Commissioning	Reset the fire detectors that have been tested and triggered to normal operation mode by switching on the detector zone again.	Fire detectors can only be reset in smoke-free, or in the case of heat sensors, cool, environments.
	Ensure that there is no alarm on the FACP. Switch on fire brigade master box und external activation.	----
	Inform the appropriate emergency services of the completion of the work.	Entry in the operating manual of the FACP.



Further information on detector replacement see brochure "Smoke detector replacement" (Part No. D8000045).

5 Automatic point-type fire detectors

5.1 Series IQ8Quad fire detectors

Automatic point-type smoke/heat detectors with integrated loop isolator with maximum reliability for objects with average to high value concentration for connection to the esserbus®/esserbus® Plus loop of the ESSER fire alarm control panels.

Features

- Designed for optimal operation on FACP Compact, IQ8Control and FlexES Control
- With multisensor fire detectors for the detection of all types of fires, even under the most difficult operating conditions.
- Detector with and without loop isolator
- Wiring in loop and spur combination
- Maximum number of detectors with cable lengths of up to 3,500 m (I-Y (St) Yn x 2 x 0.8 mm or similar)
- Up to 127 detectors and detector zones per loop installation
- Up to 32 detectors per zone
- Free wiring of display and control elements with software-based function assignment
- Optional automatic or interactive detector address allocation
- Fixed address assignment of detector location, even after detectors have been replaced or added
- Localization of wire breaks and short circuits on loop
- Detector-LED used as alarm indicator and as an indicator for detectors in service
- Adaptation to changing operating conditions
- Dedicated LED for indicating operation (green LED)
- Disconnection of individual detectors, detector zones and detection areas
- Disconnection of individual sensors or several sensors at once within a multisensor fire detector; either manually or depending on programmed time of the day
- Compensation of changing levels of air pressure, humidity, smoke concentration according to the double chamber principle
- Electronic compensation of long-term influences like aging or pollution
- Constant alarm sensitivity of multisensor fire detector for all types of fire
- Large signal to noise ratio due to the special design of the sensors and the electronics to suppress electromagnetic interference
- Reliable false alarm suppression high immunity against false alarms by means of timed evaluation of different sensor criteria
- Signal patterns not typical for fires are eliminated by using special filter algorithms
- Automatic self-monitoring of detector electronics
- Continuous loop monitoring even during short-circuits through isolating the relevant segment
- Automatic monitoring of all sensors to guarantee operational capacity and correct condition
- Short-circuit and wire break tolerant
- Alarm decision directly in the detector and forwarding of the alarms even if concentrated processing nodes fail
- Fail-safe circuit activated if communication fails

Maintenance

- Automatic maintenance request
- Heat detector identification through a black circle on the light transmission plate
- Multisensor gas detector identification through a golden loop on the circle transmission plate
- Operating time-, alarm- and fault counter in each detector
- Automatic, cyclic loop check
- Complete status interrogation from the control panel
- Operating data from all detectors in a network is collected using the service PC and via the fieldbus and control panel interface, even without the FACP

Comprehensive range of accessories

- Standard detector base and relay base
- Base adapter for ceiling mounting
- Kit for suspended ceiling mounting
- Dust cover for fire detector or detector base



An excellent overview of the IQ8Quad fire detectors, including possible applications is provided by the app: "IQ8Quad - Which fire detector for which application?"
The app is available in Google Play and the App Store.

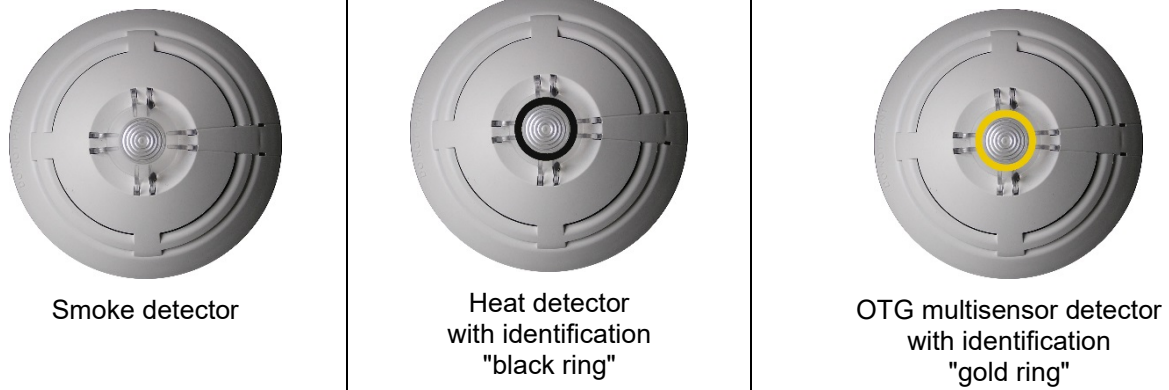

Fig. 2: Example Alarm identification of IQ8Quad fire detectors

General detector specifications^{*3}

Operating voltage	: 8 V DC ... 42 V DC
Operating voltage (EN 54-17)	: 14 V DC ... 42 V DC
Type of sensor	Heat ^{*1} Smoke ^{*2}
Monitoring area	: max. 30 m ² max. 110 m ²
Monitoring height	: max. 7.5 m max. 12 m
Air speed	: --- 0 ... 25.4 m/s
Alarm display	red LED, flashing
Storage temperature	: -25 °C ... +75 °C
Humidity	: ≤ 95% rel. humidity (non-condensing)
IP rating:	: IP 40 with base IP 42 with base + option 805570 IP 43 with base + option 805572.50 / 805573
Material	: ABS
Colour	: white (similar to RAL 9010)
Weight	: approx. 110 g
Dimensions (with base)	: Ø 117 mm, H = 62 mm

Part No.	Detector type	Specific detector specifications ^{*3}
802171 ^{*1}	Fixed heat detector	Quiescent current @ 19 V DC : 40 µA Quiescent current @ FACP _{battery} : 0.16 mA @ 27.5 V/0.22 mA @ 42V Usage temperature : -20 °C ... +50 °C Specification : EN 54-5 A1S / -17:2005 VdS approval : G 204058 Declaration of Performance : DoP-20102130701
802177 ^{*1}	Fixed heat detector	Quiescent current @ 19 V DC : 40 µA Quiescent current @ FACP _{battery} : 0.16 mA @ 27.5 V/0.22 mA @ 42V Usage temperature : -20 °C ... +65 °C Specification : EN 54-5 BS / -17:2005 VdS approval : G 208057 Declaration of Performance : DoP-20411130701
802271 ^{*1}	Rate-of-rise heat detector	Quiescent current @ 19 V DC : 40 µA Quiescent current @ FACP _{battery} : 0.16 mA @ 27.5 V/0.22 mA @ 42 V Usage temperature : -20 °C ... +50 °C Specification : EN 54-5 A1R / -17:2005 VdS approval : G 204059 Declaration of Performance : DoP-20103130701

Part No.	Detector type	Specific detector specifications* ³
802371* ²	Optical smoke detector	Quiescent current @ 19 V DC : 50 µA Quiescent current @ FACP _{battery} : 0.20 mA @ 27.5 V/0.28 mA @ 42 V Usage temperature : -20 °C ... +72 °C Specification : EN 54-7 /-17:2005 VdS approval : G 204060 Declaration of Performance : DoP-20104130701
802373* ²	OT multisensor detector	Operating voltage : 9 V DC ... 42 V DC Quiescent current @ 19 V DC : 50 µA Quiescent current @ FACP _{battery} : 0.20 mA @ 27.5 V/0.28 mA @ 42 V Usage temperature : -20 °C ... +50 °C Specification : EN 54-7 / -5 A2, CEA 4021 VdS approval : G 205070 Declaration of Performance : DoP-20111130701
802374* ²	O ² T multisensor detector	Quiescent current @ 19 V DC : 60 µA Quiescent current @ FACP _{battery} : 0.23 mA @ 27.5 V/0.33 mA @ 42 V Usage temperature : -20 °C ... +65 °C Specification : EN 54-7 / -5 B /-17:2005, CEA 4021 VdS approval : G 204061 Declaration of Performance : DoP-20105130701
802375* ²	OT ^{blue} multisensor detector	Operating voltage : 9 V DC ... 42 V DC Quiescent current @ 19 V DC : 50 µA Quiescent current @ FACP _{battery} : 0.20 mA @ 27.5 V/0.28 mA @ 42 V Usage temperature : -20 °C ... +50 °C Specification : EN 54-7 / -5 A2 /-17:2005, CEA 4021 VdS approval : G 205071 Declaration of Performance : DoP-20113130701
802379* ²	OT ^{blue} LKM multisensor detector	Operating voltage : 9 V DC ... 42 V DC Quiescent current @ 19 V DC : 50 µA Quiescent current @ FACP _{battery} : 0.20 mA @ 27.5 V/0.28 mA @ 42 V Air speed : 1 ... 20 m/s Usage temperature : -20 °C ... +50 °C Specification : EN 54-17:2005, CEA 4021 VdS approval : G 207128 Declaration of Performance : DoP-20113130701
802473* ²	OTG multisensor detector	Quiescent current @ 19 V DC : 65 µA Quiescent current @ FACP _{battery} : 0.25 mA @ 27.5 V/0.36 mA @ 42 V Monitoring area : max. 110 m ² Monitoring height : max. 12 m CO pre-alarm : approx. 75 ppm CO alarm : approx. 100 ppm Usage temperature : -20 °C ... +50 °C Specification : EN 54-7 /-5 A2 /-17:2005, CEA 4021 VdS approval : G 205072 Declaration of Performance : DoP-20115130701

*¹ Heat sensor type

*² Smoke sensor type

*³ The information applies for the entire series incl. .MAR, .N0, .NU etc.

5.2 IQ8Quad Ex (i) fire detectors for use in ex-areas

Automatic, point-type fire detectors without loop isolator for use in ex-areas.

These fire detectors produced with "intrinsic safety" ignition protection are operated either via esserbus® transponders and the Ex-barrier (Part No. 764744) or alternatively as a spur directly with the Ex-barrier (Part No. 804744) on the loop of the ESSER fire alarm control panels.

General detector data (according to ATEX)

Max. Input voltage (Ui)	: 21 V DC
Max. Input current (Ii)	: 252 mA
Max. Output current (Io)	: 10 mA
Max. internal Capacity (Ci)	: 1 nF
Ambient temperature (Ta)	: -20 °C ... +70 °C *4
Examination Certificate No.	: TÜV 09 ATEX 554910
Category	: II 2G (with Ex barrier Part No. 764744 and 804744)
Ex-protection:	: Ex ib IIC T4 Gb
Specification	: EN 60079-0:2012 + A11:2013/ -11:2012 / -25:2010

Detector identification according to ATEX

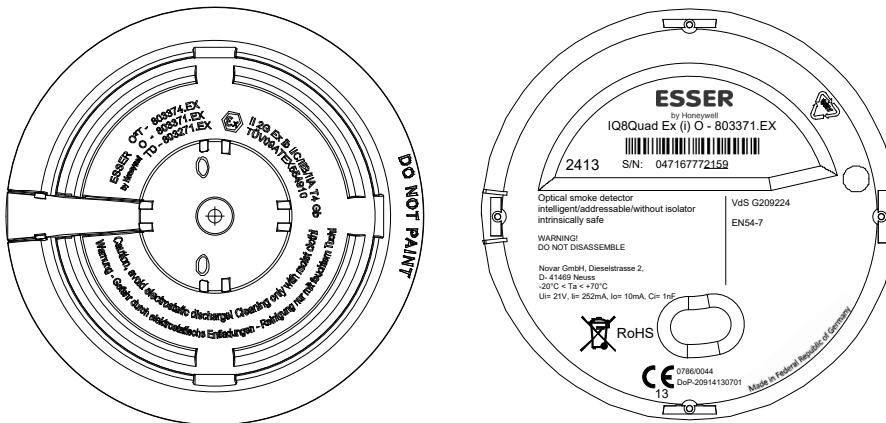

Fig. 3: Identification example → IQ8Quad Ex (i) 803371.EX

General Specifications (not ATEX)

Operating voltage	:	8 V DC ... 42 V DC	
Type of sensor	:	Heat *1	Smoke *2
Monitored area	:	max. 30 m ²	max. 110 m ²
Mounting height	:	max. 7,5 m	max. 12 m
Alarm indicator	:	red LED, flashing	
Air velocity range	:	0 ... 25,4 m/s	
Temperature, storage	:	-25 °C ... +75 °C	
Ambient humidity	:	≤ 95% relative, (non-condensing)	
IP rating	:	IP 40 with base IP 42 with base + option 805570 IP 43 with base + option 805572.50 / 805573	
Housing	:	ABS	
Colour	:	white (similar to RAL 9010)	
Weight	:	approx. 110 g	
Dimensions (with base)	:	Ø 117 mm, H = 62 mm	

*4 Ambient temperature according to ATEX

Detector Specifications (not ATEX)

Rate-of-rise heat detector 803271.EX ^{*1} / 803271.EX.F0 ^{*1} / 803271.EX.NU ^{*1}

Quiescent current @ 19 V DC	:	40 µA
Ambient temperature	:	-20 °C ... +50 °C ^{*5}
Specification	:	EN 54-5 A1R : 2000 / A1 : 2002
VdS approval	:	G 209223
Declaration of performance	:	DoP-20913130701

Optical smoke detector 803371.EX ^{*2} / 803371.EX.F0 ^{*2} / 803371.EX.NU ^{*2} / 803371.EX.IN ^{*2}

Quiescent current @ 19 V DC	:	50 µA
Ambient temperature	:	-20 °C ... +70 °C ^{*5}
Specification	:	EN 54-7 : 2006
VdS approval	:	G 209224
Declaration of performance	:	DoP-20914130701

O²T-multisensor detector 803374.EX ^{*2} / 803374.EX.F0 ^{*2} / 803374.EX.NU ^{*2} / 803374.EX.IN ^{*2}

Quiescent current @ 19 V DC	:	60 µA
Ambient temperature	:	-20 °C ... +65 °C ^{*5}
Specification	:	EN 54-7 : 2006 / -5 B : 2000 / A1 : 2002 ^{*6} , CEA 4021
VdS approval	:	G 209225
Declaration of performance	:	DoP-20915130701



- All values based on a temperature range of 25 °C.
- The FACP emergency power capacity is determined using the programming software tools 8000 or via the calculation function available at www.esser-systems.com.
- For further information, safety calculations and certifications, see Technical Information 798920.EU.xx.

EC-Type Examination acc. Construction Products Regulation (CPR)



^{*5} Ambient temperature of fire detector types for detailed system design

^{*6} Except "80337x.EX.F0" and "80337x.EX.NU"

5.3 Fire detectors series IQ8Quad with integrated alarm device

Automatic point-type smoke detector with integrated alarm device and zone isolator for connection on the esserbus®-PLus of the FlexES Control and IQ8Control fire alarm system. In case of an event, the alarm, depending on the alarm device type, can be given via flash, sounder, and/or voice output.

The IQ8Quad smoke detectors with built-in alarm device incorporate up to 4 different functionalities.

- fire detection as per EN 54-7
- integrated heat sensor as per EN 54-5
- optical alarm via flash lamp
- acoustic alarm via sounder as per EN 54-3
- acoustic alarm speech messages

Detection

The detection of the O²T multisensor detector is carried out via two integrated optical smoke detectors (except Part No. 802382) with various scattered light angles and additional heat detector sensor evaluation to detect smouldering fires through to open fires with an equivalent responsiveness. Smoke sensor signal identification to ensure smoke classification and reduction of false alarms caused, for instance, by water vapor or dust. Each detector is provided with an integrated isolator.

Alarm signaling





The alarm signaling device is activated from the control panel. No further short address needs to be allocated. It is programmed with the service and programming software tools 8000.

Alarm tone / speech message programming

For detectors with speech message and/or alarm tone function with up to five language options, up to 4 signals can be programmed. Two signals are reserved for alarm signalling and evacuation in the case of fire. Two further signals can be programmed for other events. Each signal can consist of up to four signal components, enabling one signal to be programmed as a DIN tone combined with subsequent speech messages in three different languages.

Alarm tones can be chosen from a table with various tone types. For application in schools, a break signal to signify the breaks between class can be activated.

Five different texts in different national languages are available as standard for voice announcements e.g.:

Länder-Code gem. ISO 3166 -Alpha-2	Sprachen-Code gem. ISO 639-1	Evakuierung 1	Evakuierung 2	Alarm	Testnachricht	Entwarnung
 Deutschland (DE)	de	Dies ist ein Feueralarm. Bitte verlassen Sie das Gebäude umgehend über die nächsten Fluchtwege. Die Feuerwehr ist alarmiert.	Achtung, Achtung! Dies ist eine Gefahrenmeldung. Bitte verlassen Sie das Gebäude über die nächsten Ausgänge.	Achtung, im Gebäude ist eine Gefahrensituation gemeldet worden. Bitte bleiben Sie ruhig, und warten Sie auf weitere Anweisungen.	Dies ist eine Testdurchsage.	Die Gefahrensituation ist jetzt behoben. Wir entschuldigen uns für jegliche Unannehmlichkeiten.
 England (GB)	en	This is a fire alarm. Please leave the building immediately by the nearest available exit.	Attention please. This is an emergency. Please leave the building by the nearest available exit.	An incident has been reported in the building. Please await further instructions.	This is a test message. No action is required.	The emergency is now cancelled. We apologise for any inconvenience.
 Frankreich (FR)	fr	Ceci est une alarme incendie, veuillez évacuer immédiatement les locaux par la sortie la plus proche.	Votre attention s'il vous plaît, ceci est une alarme. Veuillez évacuer les locaux par la sortie la plus proche.	Votre attention s'il vous plaît, ceci est une alarme. Veuillez évacuer les locaux par la sortie la plus proche.	Ceci est un test.	L'alarme est à présent annulée. Veuillez nous excuser pour le désagrément.
 Spanien (ES)	es	Esto es una alarma de incendio. Abandonen por favor el edificio inmediatamente por la salida de evacuación más cercana.	Atención. Esto es una emergencia. Por favor abandonen el edificio por la salida de evacuación más cercana.	Atención, se ha reportado un incidente en el edificio. Aguarden por favor otras instrucciones.	Esto es un mensaje de prueba. No se requiere ninguna acción.	La emergencia ha sido cancelada. Pedimos disculpas por las molestias causadas.
 Italien (IT)	it	Attenzione. Allarme incendio. Abbandonare l'edificio tramite l'uscita di emergenza più vicina.	Attenzione. Allarme in corso. Vi preghiamo di recarvi presso l'uscita di emergenza più vicina.	Attenzione. E' stato rilevato un allarme. Ulteriori disposizioni vi verranno comunicate appena possibile.	Attenzione. E' in corso una prova di allarme. Non è richiesta alcuna azione.	Attenzione. Cessato allarme. La situazione di normalità è stata ripristinata.

In addition, the following languages are available for specific orders. Information refer to the product catalogue.

When the basic setting is selected, signals / signal components can be continuously repeated until the signalling function is interrupted by the control panel. They can also be programmed with a repetition rate of one to three times. Thus, the break signal in schools can be deliberately set to only one repetition. In the same way, the total signal can be set to continuous repetition, with the DIN tone being played only once while subsequent speech messages are played up to three times.

Programming of the sound level

The sound level [dB (A)] can be programmed from around 64 dB (A) to around 92 dB (A) in eight stages.



- All IQ8Quad systems with integrated alarm devices can be operated only on the esserbus® PLus. Since, for physical reasons, a high noise level increases the power consumption of the alarm device, the respective load factor has to be considered when you are calculating the maximum number of alarm devices on the loop. In total, it is still possible to operate up to 127 loop devices per ring bus.
- In order to determine the battery capacity of a fire alarm control panel, the "normally closed @ FACP battery" detector data can be added.
- Fire detectors are only to be commissioned, tested and maintained using the control panel software, version V2.42R006 and higher, and the tools 8000 programming software, V1.05 and higher.
- Not suitable for operation on the 8010 extinguishing system and the 8008 FACP!
- Separate training is required for planning and commissioning of the IQ8Quad fire detector with integrated alarm devices.
- For additional information and notes, see the product group catalogue.



IQ8Quad with integrated alarm device



Ready to operate (green LED)

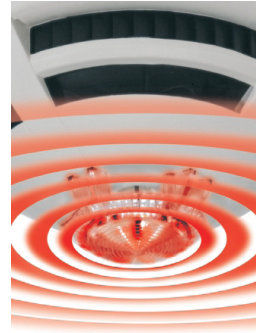

Alarm status

Fig. 4: IQ8Quad with integrated alarm device

General technical specifications^{*3}

Operating voltage	: 8 V DC ... 42 V DC
Max. monitoring area	: 110 m ²
Max. monitoring height	: 12 m
Air speed	: 0 ... 25.4 m/s
Usage temperature	: -20 °C ... +65 °C
Storage temperature	: -25 °C ... +75 °C
Humidity	: ≤ 95% rel. humidity (non-condensing)
IP rating:	: IP 43 (with base + option)
Material	: ABS
Colour	: white (similar to RAL 9010)
Weight	: approx. 145 g
Dimensions (with base)	: Ø = 117 mm, H = 67 mm

Part No.	Detector type	Specific detector specifications ^{*3}
802382	O/So - multisensor detector with sounder	Quiescent current @ 19 V DC : 80 µA Quiescent current @ FACP _{Accu} : 320 µA Load factor : 2 Sound pressure level @ DIN tone: 92 dB(A) +/- 2 dB Sounder specification : EN 54-3:2006 Specification : EN 54-7:2006 /-17:2005 VdS approval : G 206090 Declaration of Performance : DoP-20242130701
802383	O ² T/F - multisensor detector with strobe	Quiescent current @ 19 V DC : 75 µA Quiescent current @ FACP _{Accu} : 400 µA Load factor : 2 Light intensity of strobe, red : ~ 3 J Light intensity : max. 15,8 cd peak; 2,63 cd effective Specification : EN 54-7:2006/-5 B:2000/ -17:2005, CEA 4021 VdS approval : G 205011 Declaration of Performance : DoP-20111130701
802384	O ² TSo - multisensor detector with sounder	Quiescent current @ 19 V DC : 80 µA Quiescent current @ FACP _{Accu} : 450 µA Load factor : 2 Sound pressure level @ DIN tone: 92 dB(A) +/- 2 dB Sounder specification : EN 54-3:2006 Specification : EN 54-7:2006/-5 B:2000/ -17:2005, CEA 4021 VdS approval : G 205011 Declaration of Performance : DoP-20192130701
802385 / 802385.SVxx	O ² T/FSp - multisensor detector with strobe, sounder and voice output	Quiescent current @ 19 V DC : 90 µA Quiescent current @ FACP _{Accu} : 500 µA Load factor : 3 Sound pressure level @ DIN tone: -92 dB(A) +/- 2 dB Light intensity of strobe, red : ~ 3 J Light intensity : max. 15,8 cd peak; 2,63 cd effective Sounder specification : EN 54-3:2006 Specification : EN 54-7:2006/-5 B:2000/ -17:2005, CEA 4021 VdS approval : G 205011 Declaration of Performance : DoP-20192130701
802386	O ² T/Sp - multisensor detector with sounder and voice output	Quiescent current @ 19 V DC : 90 µA Quiescent current @ FACP _{Accu} : 500 µA Load factor : 3 Sound pressure level @ DIN tone: 92 dB(A) +/- 2 dB Sounder specification : EN 54-3:2006 Specification : EN 54-7:2006/-5 B:2000/ -17:2005, CEA 4021 VdS approval : G 205011 Declaration of Performance : DoP-20192130701

^{*3} The information applies for the entire series incl. .MAR, .N0, .NU etc.

5.4 Fire Detectors series ES Detect

The ES Detect automatic detector is an intelligent non-addressable detector specifically designed for operation on conventional detector zones e.g., the ES line fire alarm control panel and esserbus[®] transponder. ES Detect sets new standards in conventional technology through high quality sensors with advanced detection technology. These include not only the intelligent algorithms for fire detection but also the wide range of different types of detectors, including multisensor detectors OT^{blue} and O²T.

ES Detect also helps to save costs, because with the implemented drift compensation, ES Detect can be operated a full eight years, instead of five years for ordinary detectors, according to DIN 14675.

Numerous accessories are available from the compatible program of the IQ8Quad detector series.

The convenient maintenance with the programming software tools 8000 (in preparation) completes the full spectrum of ES Detect, from which the operating data of the detector (for example, the measured values, contamination, alarm counters, operating hours counter ...) can be read and stored. The detectors remain where they were installed, because the complete detector group can be connected to a PC and serviced via the field bus and control panel interface Plus (Part No. 789862.10).



Fig. 5: Fire Detectors series ES Detect

Features

- Optimally matched to the ES Line system.
- Optical differentiation with the ES Detect logo.
- With multisensor detectors for the detection of all fires, even under the most difficult operating conditions
- Up to 30 detectors per detection zone.
- Uniform response sensitivity of the detector for all different types of fire for the multisensory detectors
- Large distance between signal and interference magnitudes due to special sensor and electronics design for suppressing IQ8Quad with integrated alarm device electromagnetic influences
- Automatic adaptation to varying environmental influences
- Electronic compensation of long-term influences of contamination or aging
- High reliability against false alarms by temporal evaluation of different sensor criteria
- Exclusion of signal forms not typical of fires through special filter algorithms
- Automatic self-monitoring of the detector electronics
- Automatic self-monitoring of sensors for function and condition

Maintenance

- Designation of the heat detector by a black ring on the light pipe
- Hours of operation, alarm and fault counter in each detector
- Collection of the operating data from all detectors in a zone using a standard service PC and via the fieldbus and control panel interface Plus
- Detector LED for alarm display and as an identification display in the service (for maintenance with tools 8000)
- The service functions of the ES Detect series fire detectors are supported by the service and programming software tools 8000 V1.24 and later. The detector zones of the FACP with the red end-of-line element EOL-I (Part No. 808626) must be terminated.

Wide range of accessories

- Standard socket and relay base
- Socket adapter for ceiling installation
- Dust caps optional for fire detectors and detector base
- Kit for suspended mounting.

General detector specifications^{*3}

Operating voltage	:	8 V DC ... 42 V DC	
Rated voltage		9 V DC	
Alarm current		9 mA	
Reset pulse		≥ 100 ms @ 0 V	
Type of sensor		Heat ^{*1}	Smoke ^{*2}
Monitoring area	:	max. 30 m ²	max. 110 m ²
Monitoring height	:	max. 7.5 m	max. 12 m
Air speed	:	0 ... 25.4 m/s	
Alarm display		red LED, flashing	
Storage temperature	:	-25 °C ... +75 °C	
Humidity	:	≤ 95% rel. humidity (non-condensing)	
IP rating:	:	IP 40 with base IP 42 with base + option 805570 IP 43 with base + option 805572.50 / 805573	
Material	:	ABS	
Colour	:	white (similar to RAL 9010)	
Weight	:	approx. 110 g	
Dimensions (with base)	:	Ø 117 mm, H = 62 mm	

Part No.	Detector type	Specific detector specifications ^{*3}
800171 ^{*1}	Fixed heat detector	Quiescent current @ 9 V DC : 25 µA Usage temperature : -20 °C ... +50 °C Specification : EN 54-5 A1S : 2002 VdS approval : G 213068 Declaration of Performance : DoP-21291131101
800177 ^{*1}	Fixed heat detector	Quiescent current @ 9 V DC : 25 µA Usage temperature : -20 °C ... +65 °C Specification : EN 54-5 BS : 2000 VdS approval : G 213067 Declaration of Performance : DoP-21295131101
800271 ^{*1}	Rate-of-rise heat detector	Quiescent current @ 9 V DC : 25 µA Usage temperature : -20 °C ... +50 °C Specification : EN 54-5 A1R : 2002 VdS approval : G 213069 Declaration of Performance : DoP-21293131101
800371 ^{*2}	Optical smoke detector	Quiescent current @ 9 V DC : 30 µA Usage temperature : -20 °C ... +72 °C Specification : EN 54-7 : 2006 VdS approval : G 213066 Declaration of Performance : DoP-21296131101
800374 ^{*2}	O ² T multisensor detector	Quiescent current @ 9 V DC : 60 µA Usage temperature : -20 °C ... +65 °C Specification : EN 54-7 : 2006/-5 B : 2000, CEA 4021 VdS approval : G 213070 Declaration of Performance : DoP-21296131101
800375 ^{*2}	OT ^{blue} multisensor detector	Operating voltage : 9 V DC ... 42 V DC Quiescent current @ 9 V DC : 50 µA Usage temperature : -20 °C ... +50 °C Specification : EN 54-7 : 2006/-5 A2 : 2002, CEA 4021 VdS approval : G 213065 Declaration of Performance : DoP-21298131101
800379 ^{*2}	OT ^{blue} -LKM-multisensor detector	Operating voltage : 9 V DC ... 42 V DC Quiescent current @ 9 V DC : 35 µA Air velocity range : 1 ... 20 m/s Ambient temperature : -20 °C ... +50 °C Specification : EN 54-27 : 2015 VdS approval : pending Declaration of Performance : ---

^{*1} Head sensor type

^{*2} Smoke

^{*3} The information applies for the entire series incl. .MAR, .N0, .NU etc.



For further information refer to product catalogue.

5.5 Detector base and options

Detector socket for connection

- to the esserbus® / esserbus® Plus of the ESSER-BMZ 800x / IQ8Control / FlexES Control / Compact and for attaching the automatic fire detector IQ8Quad.
- to the spur lines of the ESSER-BMZ ES Line, detector zones of the esserbus® transponder and for attaching the fire detector ES Detect.

Specifications^{*3}

Ambient temperature	: -20 °C ... +72 °C
Storage temperature	: -25 °C ... +75 °C
Humidity	: ≤ 95% rel. humidity (non-condensing)
Protection rating	: IP 40 with detector IP 42 with detector + option 805570 IP 43 with detector + option 805572.50 / 805573
Connection terminals	: 0.6 mm ... 2 mm ²
Housing	: ABS
Colour	: white (similar to RAL 9010)
Weight	: approx. 70 g (805590) approx. 80 g (805591)
Dimensions (with detector)	: Ø 117 mm, H = 62 mm

*3 The information applies for the entire series incl. .MAR, .N0, .NU etc.

Part No.	Design	
805590	Standard base	---
805591	Base with relay contact	Potential-free contact, close/open function over solder/jumper available, max. load capacity 30 V DC/1 A Max. current consumption 5 µA (without detector, relay activated) Relay is activated upon triggering of detector, further programming in the customer data of the FACP.
Accessories		
805570	IP 42 protection for detector bases, flat design	
805571	Flush mount kit for detector base	
805572.50	IP 43 Damp location surface-mounting base adapter for detector bases	
805573	IP 43 protection for detector bases, deep design	
805574	Trim ring and mounting clips	
805576	Label plate e.g. for displaying the zone / detector number	
805577	Mounting adapter for intermediate ceilings	
805560	EMV isolator for detector base	
805587 805588 805589	Cover during the construction phase or during renovation work	
781550	Protective cage (Ø = 140 mm, h = 115 mm)	
Commercially option	3-pole terminal (plastic), 243-204 WAGO type (Ø 0.5 - 1.0 mm) or 273-104 WAGO type (0.75 - 2.5 mm ²)	



Diagrams of the accessory components on the following pages.

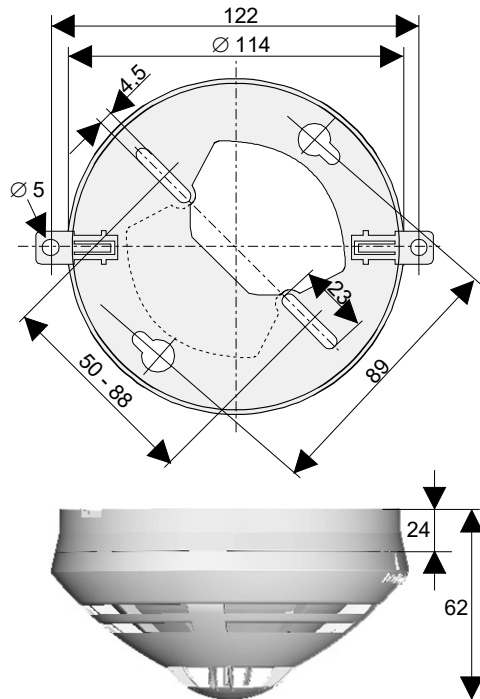

Dimensions and fixing holes

Fig. 6: Dimensions

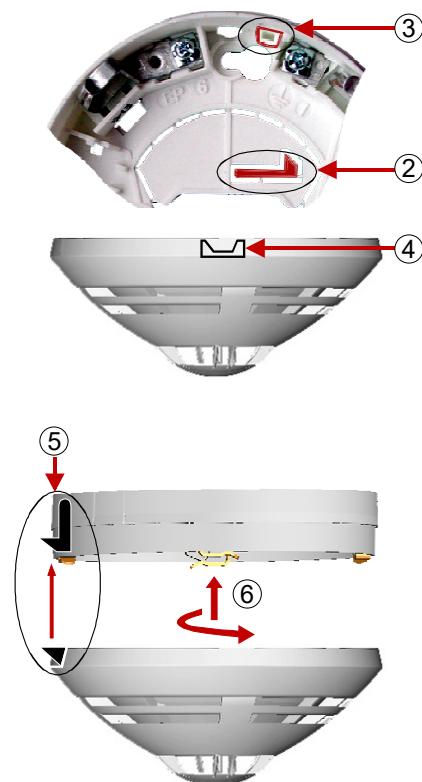

Detector removal lock

The detector removal lock is present in all bases as standard and must be activated by the installer. In order to do this, remove the lock ② from the bottom of the base and put into position ③. Detach the pull linkage ④ in the detector using a suitable knife. It is not possible to dismantle the detector using the detector picker if the detector removal lock is in use.

To remove the detector, press the lock on the opening of the housing ⑤ carefully and unscrew the detector ⑥.

Fig. 7: Detector removal lock

Art.-Nr. / Part No. 805574

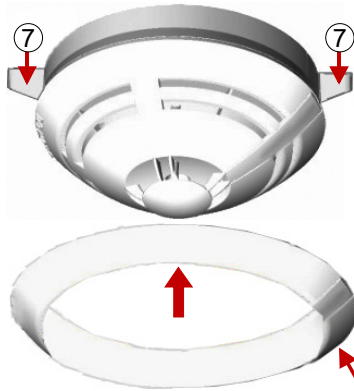

Fixing eyelets/description field (optional)

Insertable fixing eyelets ⑦ and cover ring (Part No. 805574) for the mounting base, e.g. on an installation box.

or

Insertable description field (Part No. 805576) e.g. for displaying ⑧ the zone/detector number.

Art.-Nr. / Part No. 805576



oder /
or

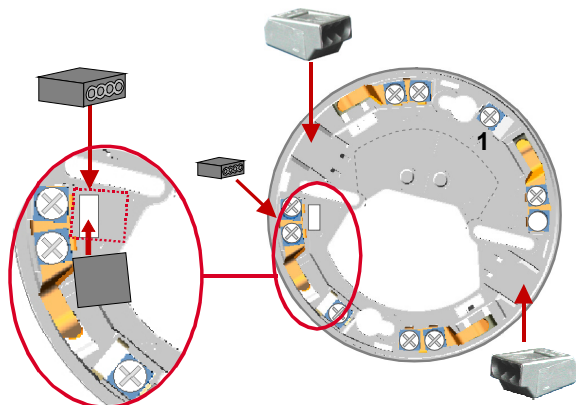

Connection terminal, 3-pole (optional)

Up to two conventional connection terminals ⑨ can be installed in the pre-installed mounts of the fire detector base.

Recommendation:
243-204 WAGO (Ø 0.5 - 1.0 mm)
273-104 WAGO (0.75 - 2.5 mm²)

- ⑨ WAGO 243-204 (Ø 0.5 - 1.0 mm)
- ⑨ WAGO 273-104 (0.75 - 2.5 mm²)

Fig. 8: Options

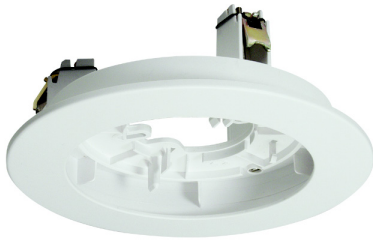
Flush-mounting housing for detector base (Part No. 805571)

The flush-mounting housing for detector bases is used for the installation of the fire detector on suspended ceilings or in places where a concealed mounting of the detector base is necessary. The detector base is locked into the flush-mounting housing and visually concealed from the outside by the attached cover ring. The detector base is then no longer visible.

Fig. 9: Flush-mounting housing for detector bases

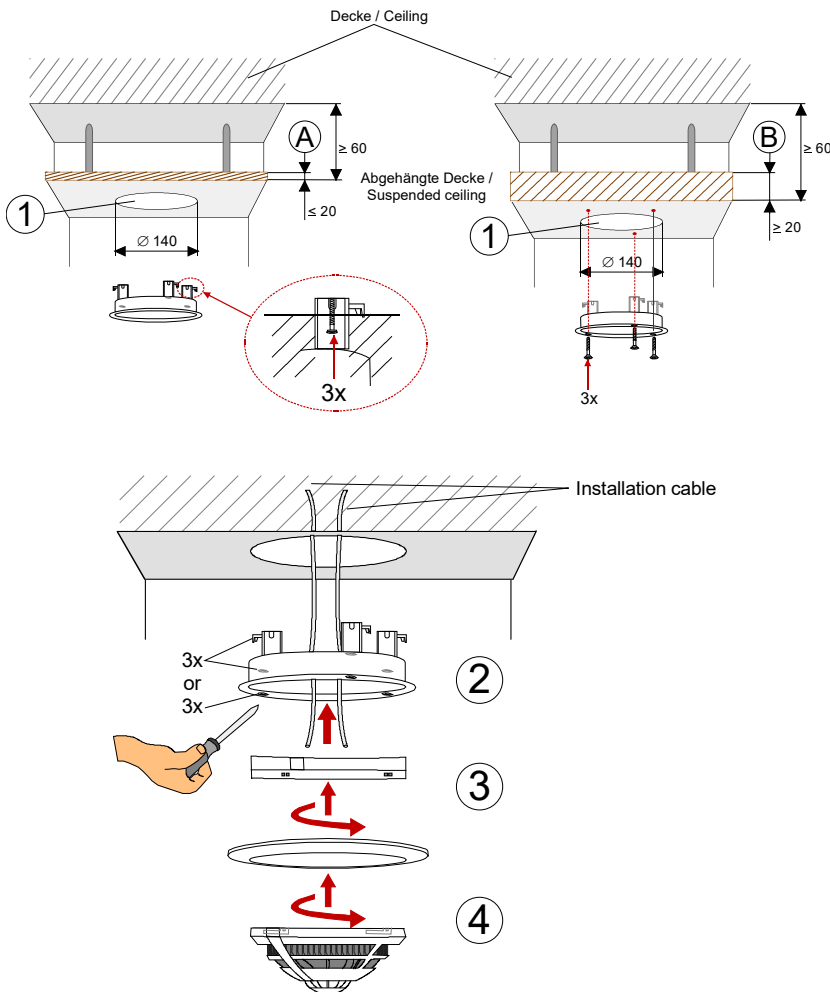

- ① Prepare an installation opening of \varnothing 140 mm, necessary installation depth \geq 60 mm.
 - Ⓐ Attach with the 3 screw claws for a ceiling thickness of up to 20 mm max.
 - Ⓑ Attach with three screws for a ceiling thickness of over 20 mm.
- ② Place flush-mounting housing in the installation opening and screw in place.
- ③ Connect detector base and insert into the plastic mounts of the flush-mounting housing and click in place.
- ④ Fit fire detector and put on cover ring.

If installed out of arm's reach, the detector removal tool (Part No. 805580) is needed to remove the fire detector.

Fig. 10: Installation



When installing, pay attention to the markings on the plastic components.

Detector removal lock

Fire detectors may not be removed using the removal tool (Part No. 805580) if there is a removal lock installed. Take off the cover ring before removing the detector.

IP 43 damp location base adapter surface-mounting (Part No. 805572.50)



The damp room socket adapter was designed specifically for the surface mounted cable feed through cable protection pipes and has three breakthrough inputs for M20 cable glands (optional).

Fig. 11: IP 43 damp location base adapter surface-mounting

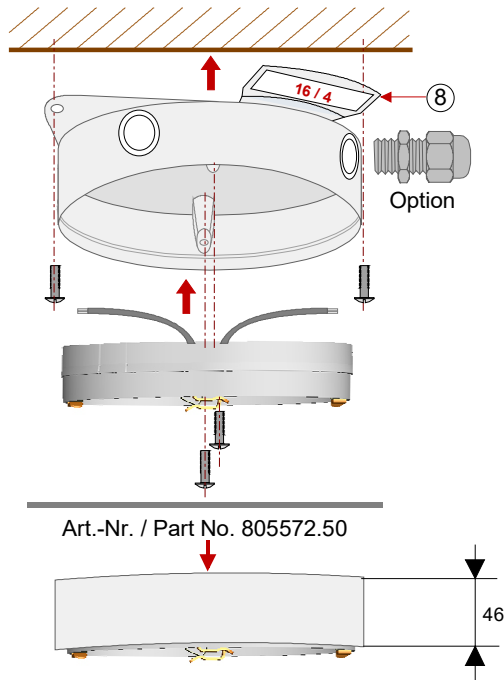

Fig. 12: Installation

IP 42 protection (Part No. 805570) and IP 43 protection (Part No. 805573)



For installation in environments with dust and humidity. IP protection prevents dust and moisture entering the detector base.

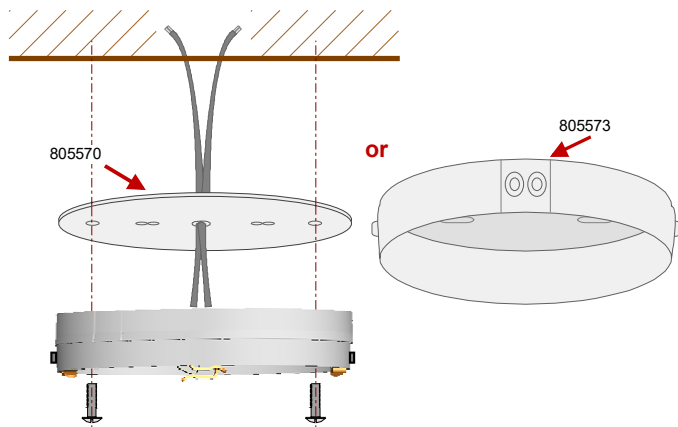

Fig. 13: IP Protection

Protective cage (Part No. 781550)



Steel basket for protection from damage and also unauthorized disconnection of the detector.

Fig. 14: Protective cage

Kit for suspended mounting (Part No. 781482)



Kit for suspended mounting of detector bases, with pendulum-linked anti-roll bar, cable entry from the top, strain relief via cable fittings and connection box with terminal input. The height of the detector can be adjusted by changing the length of the cables.

Fig. 15: Kit for suspended mounting

Covers



Detector cover for IQ8Quad detectors without integrated alarm device (Part No. 805588).



Detector cover for IQ8Quad detectors with integrated alarm device (Part No. 805589).



Base cover for the IQ8Quad fire detector base without detector (Part No. 805587).

Fig. 16: Detector and base covers



For further information refer to product catalogue.

5.6 Arrangement of point-type fire detectors

Automatic fire detectors must be planned/installed so that the fire characteristics can reach the detectors without obstruction.

The number and arrangement depend on:

- Room height
- Floor area
- Shape of ceiling and roof
- Maximum monitoring area per detector

At least one automatic fire detector must be installed in each room of the security area, excluding rooms with a low fire load or with no possibility of fire spreading. If it is expected that lives could be endangered, sub-areas where smoke could spread to are also deemed to be rooms.

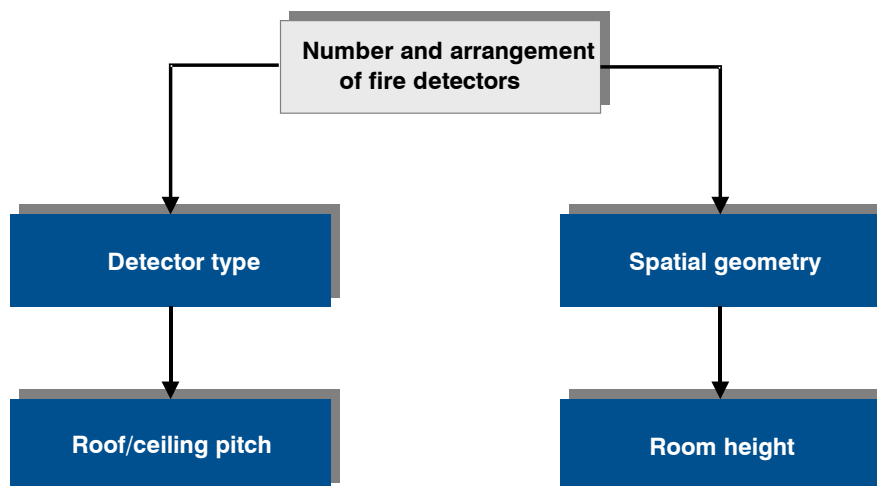

Fig. 17: Arrangement of point-type fire detectors

In rooms with forced ventilation, perforated ceilings that are used for ventilation must be sealed in a 0.5 m radius around the detector.

The number of fire detectors should be chosen so that the specified maximum monitoring areas are not exceeded.

For arrangement in two-detector dependency, the maximum surveillance areas:

- for smoke/heat detectors must be reduced by at least 30 %.
- for the activation of fire protection equipment (e.g. fire extinguishing systems) must be reduced by 50% for each detector.

In case of multisensor detectors (multi-criteria detectors), the maximum monitoring areas of detectors, which are dependent upon the height and size of the room that is to be monitored, shall apply. Multisensor detectors are not regarded as integrated 2-detector dependency, as there is no local separation of the different sensors. If the room deviates from the ideal square distribution, the greatest distance (horizontal distance) between a point-type automatic fire detector and any random point on the ceiling must be determined for smoke detectors and heat detectors, taking account of the incline of the roof and the maximum monitored area.



An excellent overview of the IQ8Quad fire detectors, including possible applications is provided by the app: "IQ8Quad - Which fire detector for which application?"
The app is available in Google Play and the App Store.

6 Manual call point (MCP)







6.1 Manual call point - large design (plastic)

The manual call point in the red housing with the 'burning house' symbol is used as a manual fire call point for the manual activation of a fire alarm/an emergency alarm in dry workplaces that are not in danger of explosion. The detector is available for other uses and areas and also comes in various designs, e.g. different housing colours and with different printed inserts.

The different coloured housings can be combined with the associated electronics modules. For every colour of housing and type of electronics module, such as those with clickable or non-clickable dosing head, there is a clear standardised allocation.



Fig. 18: Manual call point - large design

Part No.	Description	Approval
804900	Standard MCP electronics module	VdS approval with yellow housing (Part No.704902)
804901	Standard MCP electronics module with 2 micro switches	
804902	Standard MCP electronics module without catch	VdS approval with blue housing (Part No.704901)
804905	IQ8MCP electronics module with line isolator and possibility for external detector zone	VdS approval
804906	IQ8MCP electronics module with relay, without line isolator, not possibility for external detector zone	
Detector housing - large design		
704900	 red (similar to RAL 3020)	Vital for use as manual call point.
704901	 blue (similar to RAL 5015)	e.g. for a house alarm
704902	 yellow (similar to RAL 1021)	e.g. for extinguishing-agent control systems
704903	 orange (similar to RAL 2011)	e.g. RWA systems
704904	 green (similar to RAL 6002)	---
704909	 pearl white (similar to RAL 1013)	Manual call point housing for Emergency and danger detectors (EDCP detectors) acc. DIN VDE V 0827-1, see Chap. 6.1.2



When using MCP as manual call points it is vital that you use a red housing and the standard-conforming symbols.

Other housing colours and descriptions are not regarded as manual call points but rather as manual activation devices.

Accessories	
704910	Replacement glass panels (packaging units of 10)
704917	IP 55 protective tube for connection terminals (packaging units of 10)
769910	Replacement key - plastic
769911	Replacement key - metal
769916	Service key – metal (reset, open and test)

6.1.1 Additional functions

Loop isolator and ext. detector zone (Part No. 804905)

The loop isolators ensure that the system continues to operate properly in the event of a failure of any segment of the loop, as a result of a short circuit. In the case of a short circuit in the loop, the line isolators open in front of and behind the short circuit and cut off the part of the loop between the line isolators. A simple wire break does not affect the functional efficiency of the loop.

An external detector zone with max. ten standard manual call points – e.g. Part No. 804900 or 804901 – can be connected to this IQ8MCP. When activated, the address and the programmed additional information of the IQ8MCP to which the detector zone is connected are displayed.

Loop length max. 500 metres!

Relay output (Part No. 804906)

This detector provides potential-free contacts of a changeover. The relay output is activated when this detector is triggered and can be programmed as a control group in the customer data of the fire alarm control panel. Max. contact rating 30 V DC/1 A.

6.1.2 Emergency and danger call point (NGRS detector) acc. DIN VDE V 0827-1

NGRS = Emergency and danger call point

With the detector housing (Part No. 704909) and the associated electronics module (preferably Part No. 804901), the NGRS detector can be connected to an appropriate system that will be used to signal any emergency or dangerous situations, such as a VARIODYN® D1 voice alarm system.

A red release button is prescribed for the NGRS detector. Therefore, the plastic panel with the black release button on the electronics module must be replaced with the plastic panel with the red release button provided.

Scope of delivery:

- Plastic panel with red release button
- Insert labels 'Emergency alarm', 'Emergency' and 'Police emergency call'



This manual call point must not be operated on a fire alarm system or fire warning system required by building code regulations as it does not have EN 54-11 approval.

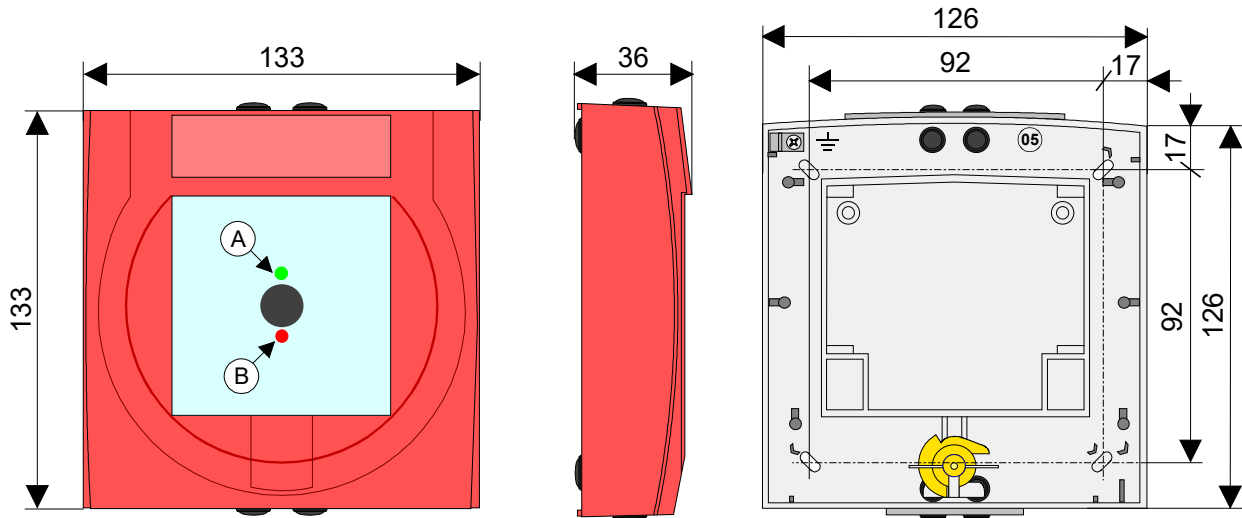

Fig. 19: Dimensions

- (A) Operation mode - LED, green flashes (only IQ8MCP)
 (B) Alarm mode - LED, red flashes

Specifications ^{*3}	Standard	IQ8
Operating voltage	8 V DC ... 30 V DC	8 V DC ... 42 V DC
Quiescent current	---	approx. 45 μ A @ 19 V DC
Alarm current	approx. 9 mA @ 9 V DC	approx. 9 mA @ 19 V DC
Contact rating S2	max. 30 V DC / 1 A	---
Number of detector / zone	10 detectors per zone (VdS approved)	max. 127 detectors per loop/ 10 detectors per zone (VdS approved)
Operating display	---	LED 1, green flashing
Alarm display	LED, red lits	LED, red flashing
Connection terminals	max. 2.5 mm ² (AWG 26-14)	
Usage temperature	-40 °C ... +70 °C	
Storage temperature	-40 °C ... +75 °C	
IP rating:	IP 44 (in housing) IP 55 (with option)	
Housing	PC ASA plastic	
Weight	approx. 236 g (with housing)	
Housing dimensions (W x H x D)	133 x 133 x 36 (mm)	
Specification	EN 54-11 : 2001, type B (only manual call point)	EN 54-11 : 2001 /-17 : 2005, type B (only manual call point)
VdS approval	G 205001	G 205002
Declaration of performance	DoP-20482130701, DoP-20194130701, DoP-20195130701	DoP-20488130701, DoP-20489130701

^{*3} The information applies for the entire series incl. .MAR, .N0, .NU etc.



For further information refer to product catalogue.

6.2 Manual call points - large design (aluminium Die-Cast Housings)

Manual call points are combined from electronic module and housing.



Fig. 20: Manual call points aluminium Die-Cast Housings

Part No.	Description
704477.10	Electronic module with 2 micro switches
804473.10	Electronic module Intelligent fire detector (IFD) with zone isolator
	Accessories
701040	Glass panel replacements acc. DIN 14655/G for MCP housing 7047xx and 7048xx
704910	Glass panel replacements acc. EN 54-11 for MCP housing 70490xx, 7048xx and 761694
769911	Metal key
769910	Plastic key
769921	Plastic sign "not in operation"
781682	Weather-proof housing, red for manual call point housing 7048xx
781692	Weather-proof housing, blue for manual call point housing 7048xx
704070	Cable fittings to increase the IP rating from IP 43 to IP 54
781693	Protective cover
704801.10	Housing with glass plane, printed with pictograms, acc. EN 54-11, red (similar to RAL 3000)
704801.11	Manual call point housing Aluminium Die-Cast, printed with pictograms and Feuerwehr, acc. EN 54-11, red (similar to RAL 3000)
704804	Housing with glass plane, printed with house alarm ESSER, red (similar to RAL 3000)
704854	Housing with glass plane, printed with house alarm ESSER, blue (similar to RAL 5009)
704874	Housing with glass plane, printed with house alarm ESSER, yellow (similar to RAL 1018)
704800	Housing with glass plane, neutral without pictograms, red (similar to RAL 3000)
704850	Housing with glass plane, neutral without pictograms, blue (similar to RAL 5009)
704870	Housing with glass plane, neutral without pictograms, yellow (similar to RAL 1018)
704890	Housing with glass plane, neutral without pictograms, grey (similar to RAL 7035)

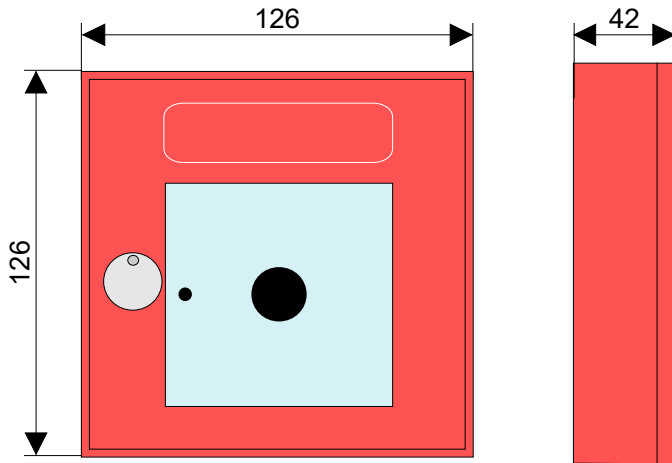

Fig. 21: Dimensions

Specifications	704477.10	804473.10
Operating voltage	8 ... 30 V DC	8 ... 42 V DC
Quiescent current	---	approx. 45 μ A @ 19 V DC
Alarm current	typ. 9 mA @ 9 V DC	typ. 9 mA @ 19 V DC
Contact load	30 V DC / 1 A	
No. of detector / zone	10 detectors per zone (according to VdS)	max. 127 detectors per loop / 10 detectors per zone (according to VdS)
Alarm display	LED, red	
Connection terminal	max. 1.5 mm ²	
Application temperature	-40 °C ... +70 °C	
Storage temperature	-40 °C ... +75 °C	
IP rating	IP 43 (IP 54 with optional 704070)	
Housing	aluminium, die-cast	
Weight	approx. 600 g	
Dimensions Housing (W x H x D)	126 x 126 x 42 (mm)	
Declaration of Performance	DoP-20478130701	DoP-20481130701

6.3 Manual Call Point – large design (accessories)

Protective cover for manual call points (Part No. 781693)

The protective cover for manual call points and manual activation devices prevents dust and humidity and also protects against accidental activation. The protective cover is suitable for almost all conventional manual call points. The optional spacer (Part No. 781698) is only necessary for surface mounting. With the optional IP 55 Kit (Part No. 781699), the IP rating can be increased from IP 44 to IP 55. The optional spacer (Part No. 781698) enables cables to be surface-mounted.

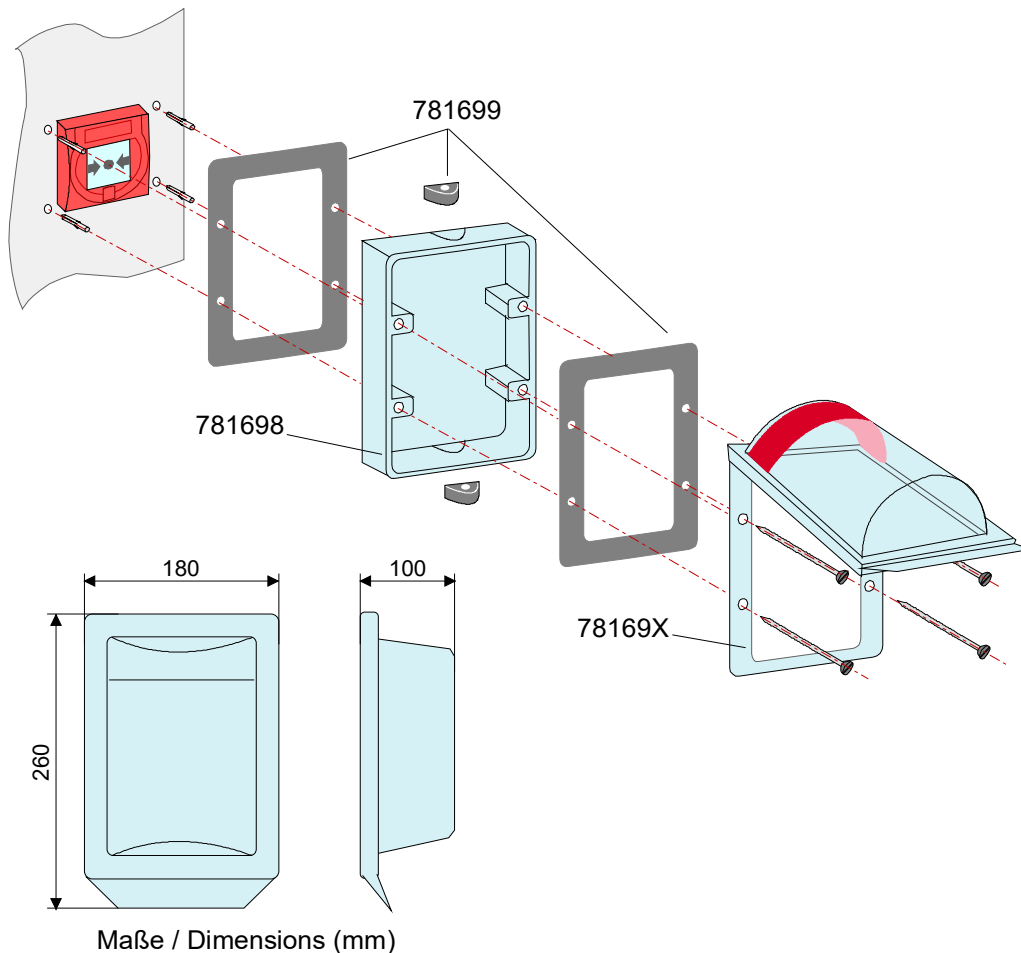

Fig. 22: Protective cover for manual call points

Specifications

IP rating:	: IP 44 (IP 55 with optional 781699)
Dimensions (W x H x D)	: 180 x 260 x 100 (mm)
Weight	: approx. 590 g



For further information refer to product catalogue.













6.4 Manual call point - small design

The MCP in red housing with the "burning house" symbol is used as a manual call point for the manual activation of a fire alarm/an emergency alarm in dry workplaces that are not in danger of explosion. The detector is available for other uses and areas, and also comes in various designs, e.g. different housing colours and with different printed inserts.

The different coloured housings can be combined with the associated electronics modules.



Fig. 23: Manual call point - small design

Part No.	Description	Approval
804970	Standard MCP, red with glass pane	VdS approval
804960	Standard MCP, IP66, red with glass pane	
804971	IQ8MCP, red with glass pane	
804973	IQ8MCP, red with plastic triggering element	
804961	IQ8MCP, IP66 / 67, red with glass pane	
804950	Standard MCP electronic module	
804951	Standard MCP electronic module with 2 nd micro-switch	
804955	IQ8MCP electronic module	
804956	IQ8MCP electronic module w/o isolator, with relay	
Detector housing - small design		Surface mount housing,
704950	 red (similar to RAL 3020)	704980  red (similar to RAL 3020)
704951	 blue (similar to RAL 5015)	704981  blue (similar to RAL 5015)
704952	 yellow (similar to RAL 1021)	704982  yellow (similar to RAL 1021)
704953	 orange (similar to RAL 2011)	704983  orange (similar to RAL 2011)
704954	 green (similar to RAL 6002)	704984  green (similar to RAL 6002)
704955	 grey (similar to RAL 7035)	704985  grey (similar to RAL 7035)

Accessories	
704960	Spare glass pane (pack of 10)
704961	Front foil with universal text, white lettering (pack of 10)
704964	Resettable, plastic element, white (pack of 10)
704965	Protective kit for MCP and TAL to prevent inadvertent activation
704966	Plastic spare key (pack of 10)
704967	Mounting frame for small MCP, incl. cover plate red and white (132 x 132 x 8 mm)

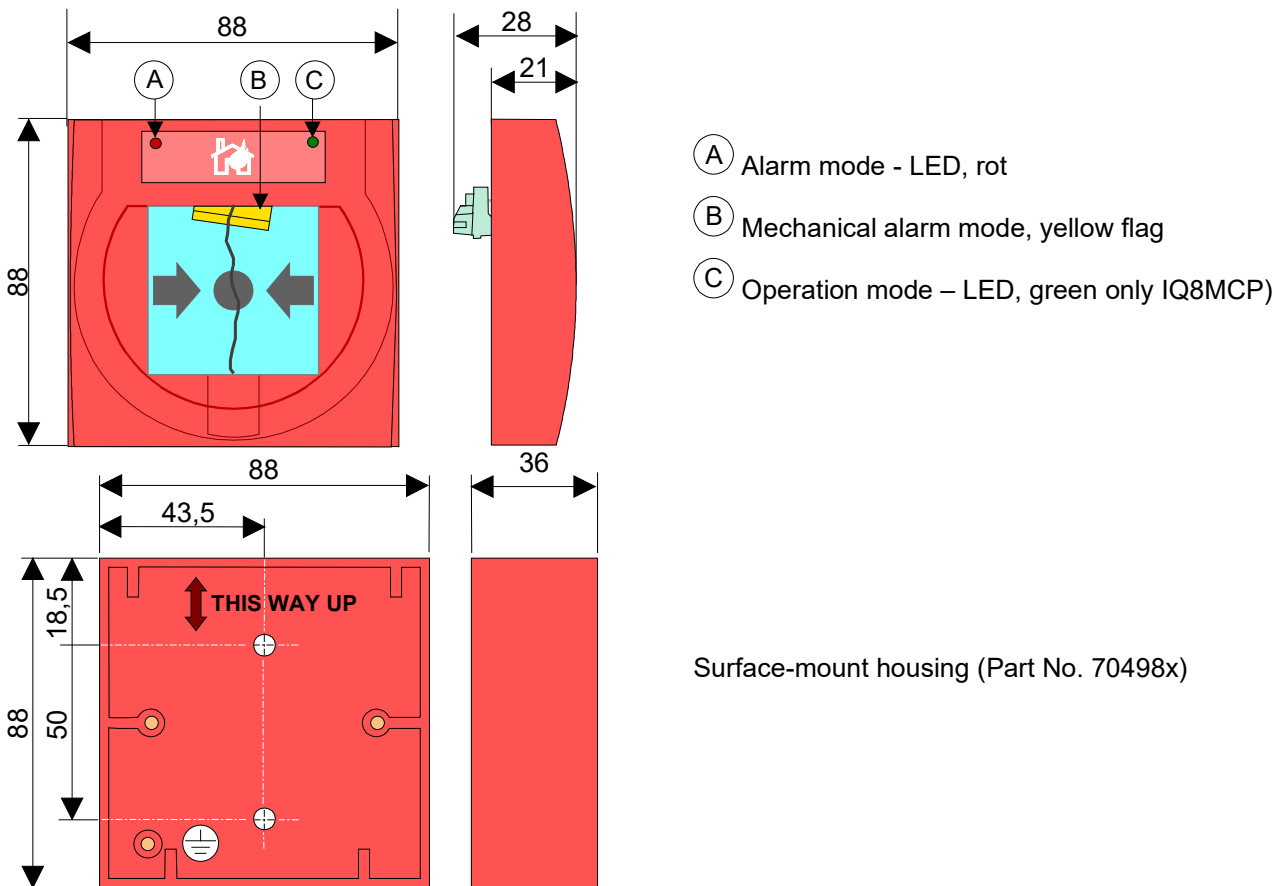
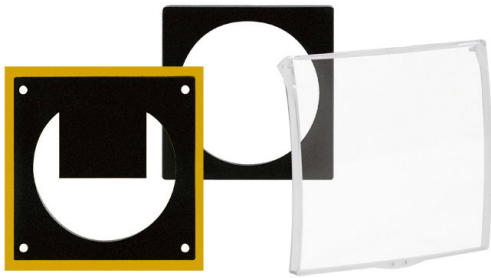

Fig. 24: Dimensions

Specifications ^{*3}	Standard	IQ8
Operating voltage	8 V DC ... 30 V DC	8 DC ... 42 V DC
Quiescent current	---	approx. 45 μ A @ 19 V DC
Alarm current	approx. 9 mA @ 9 V DC	approx. 9 mA @ 19 V DC
Number of detectors	10 detectors per zone (according to VdS)	max. 127 detectors per loop (according to VdS)
Alarm display		red LED / yellow flag
Operating display	---	green LED
Connection terminals		max. 1,5 mm ² (AWG 30-14)
Usage temperature		-40 °C ... +70 °C
Storage temperature		-40 °C ... +75 °C
IP rating		IP 43 (in housing) IP 55 (with option) IP 66 / IP 67 (only 804960 and 804961)
Housing		PC ASA plastic
Weight		approx. 110 g
Housing dimensions (W x H x D)		88 x 88 x 21 (mm)
Dimensions incl. mounting housing		88 x 88 x 57 (mm)
Specification		EN 54-11:2001 / A1:2005, type A
VdS approval	G 205131	G 205132
Declaration of Performance	DoP-20486130701, DoP-20485130701	DoP-20492130701, DoP-20491130701, DoP-20882130701

^{*3} The information applies for the entire series incl. .MAR, .N0, .NU etc.

6.5 Manual call point - small design (accessories)



Protective kit for MCP and TAL (Part No. 704965)

To protect against accidental activation.

The cover is inserted into the grooves at the side of the housing upper part and can also be sealed in place.

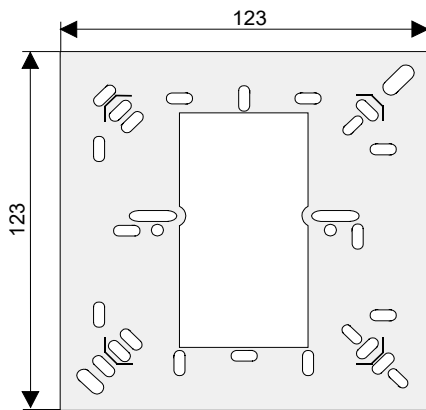

Mounting frame (Part No. 704967)

With red covering screen for universal wall installation manual call point

Dimensions: 123 x 123 mm (incl. covering screen)

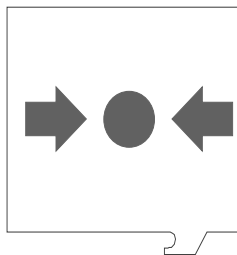

Plastic operating panel (Part No. 704964)

Can be reset, white.

The plastic operating panel is not destroyed when pressed and can be reused over and over again for the activation of the detector.

Fig. 25: Accessories



For further information refer to product catalogue.

6.6 Manual Call Points special design

6.6.1 Standard MCP Ex (i) and IQ8MCP Ex (i) for use in Ex areas

Conventional and addressable manual call points for use in Ex areas. These manual call points with "intrinsic safety" ignition protection are operated over esserbus® transponders and Ex barrier (Part No. 764744) or alternatively as a spur - exclusively IQ8MCP Ex (i) - directly with Ex barrier (Part No 804744) on the loop of the ESSER fire alarm control panels.

General detector data according to ATEX

	Standard MCP Ex (i) 804920.EX 804960.EX	IQ8MCP Ex (i) 804924.EX 804961.EX
Max. Input voltage (Ui) :	21 V DC	
Max. Input current (Ii) :	252 mA	
Max. Output current (Io) :	---	10 mA
Max. internal Capacity (Ci) :	---	1 nF
Ambient temperature (Ta) :	- 20 °C ... + 70 °C	
Examination Certificate No. :	TÜV 14 ATEX 150860	TÜV 14 ATEX 150789
Category :	II 2G (with Ex barrier Part No. 764744 / 804744)	
Ex-protection :	Ex ib IIC T4 Gb	
Specification :	EN 60079-0:2012 + A11:2013/ -11:2012	EN 60079-0:2012 + A11:2013/ -11:2012/ -25:2010

Detector identification according to ATEX

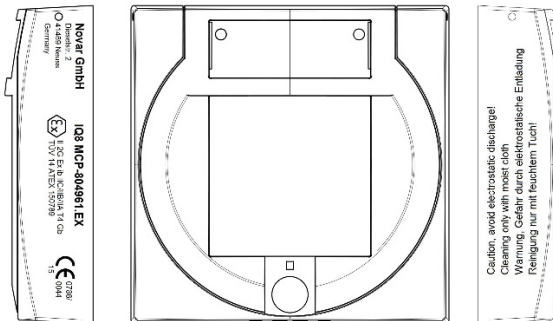

Fig. 26: Identification example → IQ8MCP Ex (i)

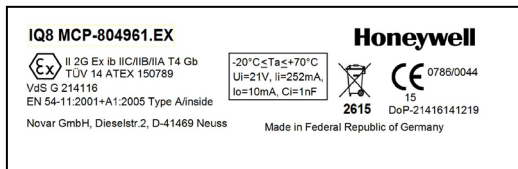

Fig. 27: Example identification plate IQ8MCP Ex (i)



Fig. 28: EC-Type Examination acc. Construction Products Regulation (CPR)

Detector Specifications (not ATEX)		
	Standard MCP Ex (i) 804920.EX	IQ8MCP Ex (i) 804924.EX
Operating voltage	: 8 V DC ... 30 V DC	8 V DC ... 42 V DC
Contact rating S2	: max. 30 V DC / 1 A	---
Quiescent current	: ---	approx. 45 µA @ 19 V DC
Alarm current	: approx. 9 mA @ 9 V DC	approx. 9 mA @ 19 V DC, pulsed
Operating indicator	: ---	LED, green
Alarm indicator	: LED, red	LED, red
Terminals	: max. 2,5 mm ² (AWG 26-14)	
Ambient temperature	: -20 °C ... +70 °C	
Storage temperature	: -30 °C ... +75 °C	
Protection rating	: IP 44	
Housing	: PC ASA plastic	
Weight	: approx. 236 g (in housing)	
Dimensions housing (w x h x d)	: 133 x 133 x 36 (mm)	
Specification	: EN 54-11 : 2001 + A1:2005, type B	
VdS approval	: G 214113	G 214114
Declaration of performance	: DoP-21417141219	DoP-21418141219

	Standard MCP Ex (i) 804960.EX	IQ8MCP Ex (i) 804961.EX
Operating voltage	: 8 V DC ... 30 V DC	8 V DC ... 42 V DC
Quiescent current	: ---	approx. 45 µA @ 19 V DC
Alarm current	: approx. 9 mA @ 9 V DC	approx. 9 mA @ 19 V DC, pulsed
Operating indicator	: ---	green LED
Alarm indicator	: red LED and yellow flag	
Terminals	: max. 1,5 mm ² (AWG 30-14)	
Ambient temperature	: -20 °C ... +70 °C	
Storage temperature	: -30 °C ... +75 °C	
Protection rating	: IP 66 / 67	
Housing	: PC ASA plastic	
Colour	: red (similar to RAL 3020)	
Weight	: approx. 255 g	
Dimensions housing (w x h x d)	: 88 x 88 x 21 (mm)	
Dimensions incl. mounting housing	: 88 x 88 x 57 (mm)	
Specification	: EN 54-11:2001 + A1:2005, Typ A	
VdS approval	: G 214115	G 214116
Declaration of performance	: DoP-21415141219	DoP-21416141219



For further information, safety calculations and certifications, see Technical Information 798920.EU.xx.

6.6.2 Addressable MCP, IP66

Addressable manual call point in conformity with EN 54-11 type B with loop isolator (Part No. 761694) for use on esserbus® / esserbus® Plus for manually triggering fire alarms or hazard alarms. For outdoor application or application in damp environments.



Fig. 29: Addressable MCP, IP66

Specifications

Operating voltage	: 8 ... 42 V DC
Quiescent current	: approx. 45 µA @ 19 V DC
No. of detector / zone	: max. 10 (according to VdS), 127 / loop
Alarm display	: LED red
Connection terminal	: max. 1.5 mm ²
Application temperature	: -20 °C ... 70 °C
Storage temperature	: -25 °C ... 75 °C
Type of protection	: IP 66
Housing	: PC-plastic
Color	: red, similar to RAL 3000
Weight	: approx. 700 g
Dimensions	: 135 x 135 x 61 (mm)
Declaration of Performance	: DoP-20882130701



For further information refer to product catalogue.

6.7 Configuration of manual call points (MCP)

Manual call points should ...

- be installed at intervals of max. 100 m in escape and safety routes in workplaces and facilities at risk of fire
- be installed so that they are clearly visible and easily accessible
- be installed at 1.4 m \pm 0.2 m height (pushbutton/control panel above the floor)
- receive adequate daylight or illumination from an alternative light source. If security lighting is available, this should also illuminate the manual call point
- if necessary be labelled with an additional transparent adhesive sticker acc. DIN 4066
- be clearly labelled if they are not functioning ("not in operation").



In particularly dangerous areas or depending on the use and condition of a building, the distances between two manual call points should not exceed 40 m. The MCP number and installation position arrangement must ensure that a person has to cover a distance of no more than 30 m to reach the next manual call point.



Fig. 30: Configuration of manual call points (MCP)

7 IQ8Wireless – Wireless Components and accessories

The wireless modules meet the requirements of EN 54-25 and are compatible with ESSER fire alarm systems. Communication between the RF devices is set up via a dual band transmission mode. The RF-technology applies frequency hopping to enable highest transmission security. In case of interference, the frequency band and the radiocommunication channels are automatically modified. If the entire band and the receiver are blocked due to high interference level, a fault signal is transmitted to the fire alarm panel. Thus, secure and reliable wireless transmission is provided.

The transmission range in open air is up to 300 m. Inside the building, the transmission range varies, depending on building structure, wall thickness or use of reinforced concrete.

IQ8Wireless radio technology facilitates the cable-free connection of IQ8Quad automatic fire detectors (with and without alarm signaling devices), manual call points / MCP and the IQ8Alarm signaling device to the ESSER fire alarm systems.

Already existing fire alarm systems can be expanded using the wireless technology or complete fire alarm systems can be realized for smaller objects with wireless components as well.

The allocation of the wireless components to a wireless transponder or wireless gateway takes place via the tools 8000 programming software.

The optimal installation site as well as the maximum possible transmission distance can be conveniently and quickly transmitted via the software integrated field strength measurement.



- These devices were designed, produced and labelled for operation within the countries of the European Union (EU) in accordance with the current EU standards and requirements. If the device is installed outside of the EU, national guidelines and requirements must be taken into consideration.
- Commissioning is only permitted if the relevant national and local requirements are complied with and fulfilled.
- Using the IQ8Alarm Plus signaling device the esserbus® PLus is needed.
- The wireless activation of the alarm devices is carried out without synchronicity.
- The batteries to be used are components of the device approval according to EN 54 and are specified by the manufacturer. With the IQ8Wireless radio components, only the approved batteries with Part No. 805597 may be used. Use of batteries other than those specified by us automatically voids the product's device approval (VdS-approval) and may not be used for example in Germany in fire alarm systems under legal building regulations.



The service life of the batteries depends on the type of detector/device used, on the ambient temperature and on other ambient conditions.

Please note important instructions for usage of batteries in manual Part No. 798941.10 (available at the website).

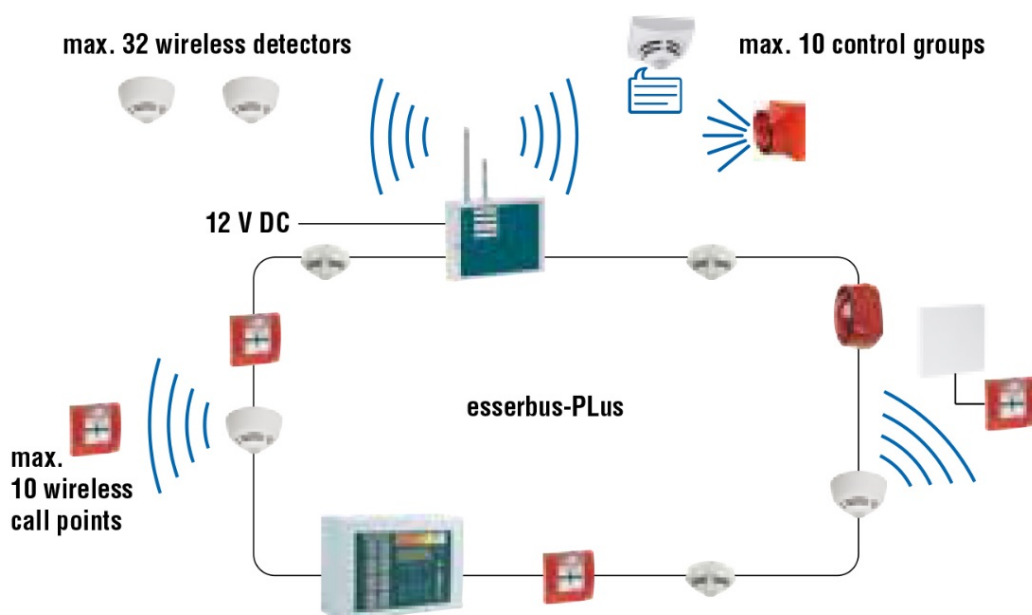

Fig. 31: IQ8Wireless – Wireless Components and accessories







	<p>IQ8Wireless transponder wall mount (Part No. 805595.10)</p>
	<p>IQ8Wireless Gateway (Part No. 805594.10) for automatic IQ8Quad fire detector (without integrated alarm device).</p>
	<p>IQ8Wireless detector base (Part No. 805593.10) for automatic IQ8Quad fire detector (without integrated alarm device). Scope of delivery with detector base (Part No. 805590)</p>
	<p>IQ8Wireless universal interface, scope of delivery without mounting frame red (Part No. 805601.10), white (Part No. 805602.10)</p>
	<p>IQ8Wireless mounting frame, red + white (Part No. 805603) for alarm device IQ8Alarm</p>
	<p>IQ8Wireless mounting frame, white (Part No. 805604) for automatic IQ8Quad fire detector</p>
	<p>IQ8Wireless cover for wireless interface, red and white (Part No.805605)</p>
	<p>Mounting frame for small MCP, red and white (Part No. 704967)</p>

Fig. 32: IQ8Wireless – Wireless Components

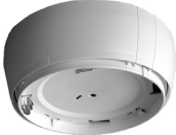
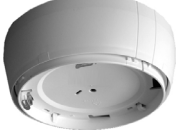

For further information refer to product catalogue.

The following detectors and alarm devices may be used together with the IQ8Wireless components:

	<p>IQ8Quad fire detector (without integrated alarm device)</p>
	<p>IQ8Quad fire detector with integrated strobe, sounder and/or voice alarm device</p>
	<p>IQ8MCP - Manual Call Point, large design</p>
	<p>IQ8MCP - Manual Call Point, small design</p>
	<p>Alarm device IQ8Alarm Plus</p>

Fig. 33: Detectors and alarm devices IQ8Wireless – Wireless Components

7.1 IQ8Wireless transponder

The mounting position of the IQ8Wireless transponder (Part No. 805595.10) should be chosen to ensure a good radio connection (field strength) between the IQ8Wireless transponder and the associated IQ8Wireless detector bases.

The four LED, each with their own description field, on the front of the housing provide information about the status of the wireless transponder.

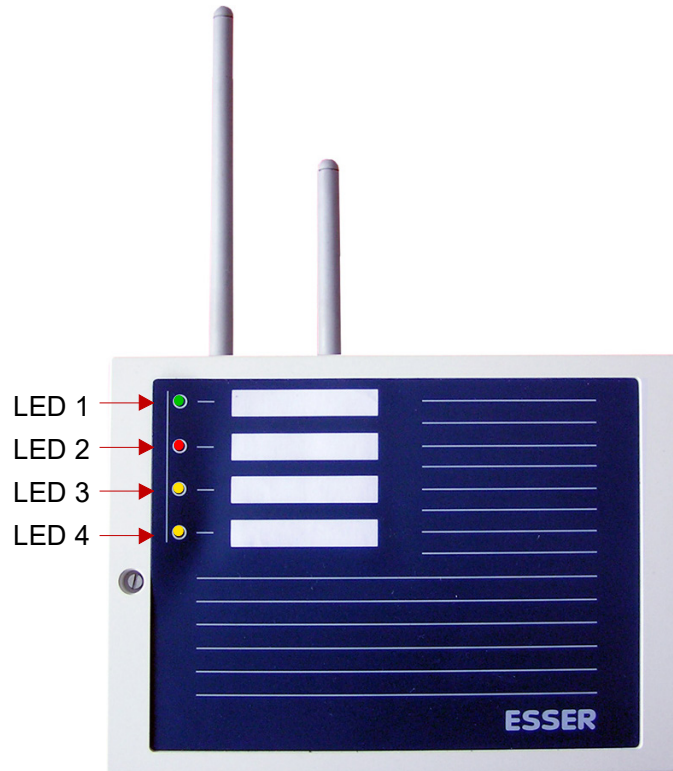

Fig. 34: IQ8Wireless transponder

LED 1	Operation (green) lights up when in normal operation
LED 2	Common fire (red) lights up if the fire alarm of an assigned RF device is detected. The relay >Common fire< is activated.
LED 3	Common fault (yellow), display not stored lights up if a fault alarm of the IQ8Wireless transponder or assigned Wireless device is detected. The activation of the relay >common fault< is interrupted and the relay contact changes the switching status.
LED 4	Initialisation (yellow) Lights up during the activation / recognition process of the IQ8Wireless transponder when the Wireless device is detected.

7.1.1 Features and system limitations IQ8Wireless transponder

Possible operating modes

- Stand-alone
- Connection to a standard detection zone of a fire alarm control panel
- Connection to the esserbus® or esserbus® PLus

System limits

- Max. 32 IQ8Wireless detector bases (incl. IQ8Quad fire detector) per transponder or
- Maximum 10 IQ8MCP / Manual Call Points (incl. IQ8Wireless Interface) per transponder.
- If the IQ8Wireless transponder is connected to a conventional detector zone, all assigned IQ8Wireless devices form one common detector zone (refer to VdS Guidelines)

System limits for the loop

- An IQ8Wireless transponder is a device on the loop and requires 1 address
- An assigned IQ8Wireless detector base (incl. IQ8Quad fire detector) is a device on the loop and requires 1 address
- An IQ8Wireless MCP (incl. IQ8Wireless Interface) is a device on the loop and requires 1 address
- An IQ8MCP (incl. IQ8Wireless Interface) is a device on the loop and requires 1 address
- Max. 127 devices (addresses) per loop
- Max. 10 IQ8Wireless transponders per loop
- Every automatic IQ8Quad fire detector (with IQ8Wireless detector base) or IQ8MCP / Manual Call Points (incl. IQ8Wireless Interface) can be configured as a separate detector zone



Automatic fire detectors and MCPs may not be operated on one and the same IQ8Wireless transponder.

In practice, for each loop this means

- Max. 123 IQ8Wireless bases (incl. IQ8Quad fire detectors without integrated alarm device), divided between 4 IQ8Wireless transponders or
- Max. 117 IQ8Wireless bases (incl. IQ8Quad fire detectors without integrated alarm device), divided between 10 IQ8Wireless transponders

In addition to this, when using the maximum number allowed, no additional Wireless or bus devices can be connected to the loop.

If additional bus devices such as detectors or esserbus® transponders are operated on the loop, the corresponding number of Wireless devices is reduced.



For further information refer to documentation of the IQ8Wireless devices.

Specifications ^{*3}

Loop

Rated voltage	:	8 V DC to 42 V DC
External power supply		
Power supply	:	9 V DC ... 30 V DC
Contact rating	:	max. 30 V DC / 1 A
Quiescent current	:	approx. 17 mA @ 12 V DC
Alarm current	:	approx. 18 mA @ 12 V DC
Frequency band	:	868 MHz (7 channels) 433 MHz (16 channels)
Bandwidth	:	110 KHz
Modulation	:	FSK
Baud rate	:	19,2 KBd
Transmission level	:	10 mW
Range of transmission path	:	up to max. 300 m (dependent on mounting location and ambient conditions)
Ambient temperature	:	-5 °C ... +55 °C
Storage temperature	:	-10 °C ... +60 °C
Protection rating	:	IP 42
Housing	:	PC/ASA plastic
Colour	:	white, similar RAL 9010
Weight	:	approx. 250 g
Dimension	:	200 x 280 x 39 (mm) - including aerial
Specification	:	EN 54-17 : 2005 / -18 : 2005 / -25 : 2008
VdS approval	:	G 205113
Declaration of Performance	:	DoP-20621140331

^{*3} The information applies for the entire series incl. .MAR, .N0, .NU etc.

7.2 IQ8Wireless gateway

The mounting height of the IQ8Wireless gateway (Part No. 805594.10) for IQ8Quad fire detectors, as device of the loop, must be coordinated with the type of fire detector which is installed. Additionally the mounting position of the IQ8Wireless gateway should be selected to ensure a good radio connection (signal strength) between the IQ8Wireless gateway and the associated IQ8 Wireless devices.

Conventional detector base (Part No. 805590) of an already installed loop.

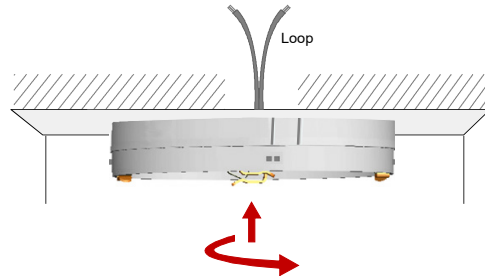

IQ8Wireless gateway with cover



IQ8Quad fire detectors without integrated alarm device

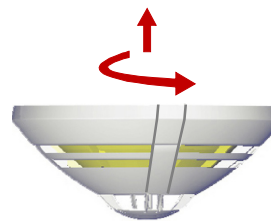

Fig. 35: IQ8Wireless gateway

7.2.1 Features and System limitations IQ8Wireless gateway

Operating mode

- Connection to the esserbus® or esserbus® PLus

System limitations

- The Wireless gateway occupies 1 esserbus® address
- Max. 127 devices (addresses) per loop
- Max. 9 Wireless transponders per loop
- Max. 10 IQ8Wireless bases and/or IQ8Wireless interfaces in total per Wireless gateway
- Max. 18 IQ8Wireless gateways per FACP IQ8Control C
- Max. 45 IQ8Wireless gateways per FACP IQ8Control M und FlexES Control
- Place of installation for an IQ8Quad fire detector (without integrated alarm device). A remote alarm indicator may be connected for the installed detector.

On an IQ8Wireless gateway such as on an IQ8Wireless transponder IQ8Wireless bases (incl. IQ8Quad fire detectors without an integrated alarm device) or IQ8MCP / Manual Call Points (incl. IQ8Wireless interfaces) can be operated.



The total number of loop devices of the loop will be reduced by 12 devices for each connected IQ8Wireless Gateway.

In practice, for each loop this means

- For the IQ8Wireless gateway this means a maximum of 9
- a maximum of 10 IQ8Wireless bases or 10 IQ8MCP / Manual call points (incl. IQ8Wireless interfaces)

In addition to this, when using the maximum number allowed, no additional Wireless or bus devices can be connected to the loop.

If additional bus devices such as detectors or esserbus® transponders are operated on the loop, the corresponding number of Wireless devices is reduced.

Specifications ^{*3}

Operating voltage	: 8 V DC to 42 V DC
Batteries	: 4 batteries per 3.6 V (AA)
Batteries lifetime	: approx. 3 years
Current consumption	: 400 µA up to max. 2.5 mA
Frequency band	: 433/868 MHz
Transmission power	: max. 10 mW
Range	: to max. 300 m
Usage temperature	: -5 °C ... +55 °C
Storage temperature- without batteries	: -20 °C ... +70 °C
- with batteries	: +25 °C ± 10 °C
Humidity	: ≤ 95% rel. humidity (non-condensing)
IP rating	: IP 42
Material	: ABS-V0
Colour	: white (similar to RAL 9010)
Weight	: approx. 265 g (incl. batteries)
Dimensions (Ø x H)	: Ø 135 mm x 88 mm, incl. fire detector
Specification	: EN 54-17 : 2005 / -18 : 2005 / -25 : 2008
VdS approval	: G 206091
Declaration of Performance	: DoP-20620140331

*3 The information applies for the entire series incl. .MAR, .N0, .NU etc.

7.3 IQ8Wireless detector base

The mounting height of the IQ8Wireless base (Part No. 805593.10) must be coordinated with the type of fire detector which is installed. Additionally, the mounting position of the IQ8Wireless base should be selected to ensure a good radio connection (signal strength) between the IQ8transmitter/receiver unit and the associated IQ8Wireless devices.

Standard detector base (Part No. 805590) supplied device

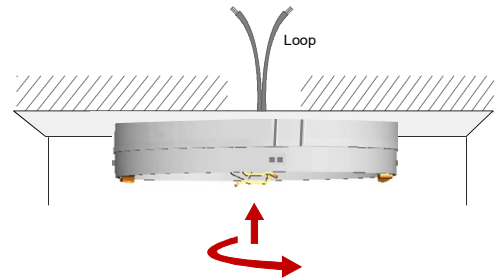

IQ8Wireless base with cover.



Suitable detectors

- Fixed heat detector (Part No. 802171, 802177, 803171)
- Rate-of-rise heat detector (Part No. 802271, 803271)
- Optical smoke detector (Part No. 802371, 803371)
- O²T multisensor fire detector (Part No. 802374, 803374)
- OTG multisensor fire detector (Part No. 802473)

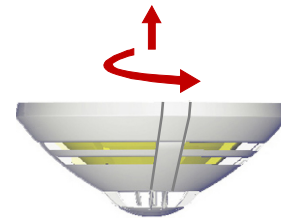

Fig. 36: IQ8Wireless detector base

Specifications ^{*3}

Operating voltage	: 4 x 3.6 V (AA) batteries
Battery lifetime	: approx. 3 years
Current consumption	: approx. 50 µA
Frequency band	: 433/868 MHz
Range	: up to 300 m outdoors, up to 30 m in buildings
Transmission power	: max. 10 mW
Usage temperature	: -5 °C ... +55 °C
Storage temperature	- without batteries : -20 °C ... +70 °C - with batteries : +25 °C ± 10 °C
Humidity	: ≤ 95% rel. humidity (non-condensing)
IP rating	: IP 42
Material	: ABS-V0
Colour	: white (similar to RAL 9010)
Weight	: approx. 315 g (incl. batteries)
Dimensions (∅ x H)	: ∅ 135 mm x 88 mm, incl. fire detector
VdS approval	: G 205112
Specification	: EN 54-18 : 2005 / -25 : 2008
VdS approval	: G 205112
Declaration of Performance	: DoP-20622140326

^{*3} The information applies for the entire series incl. .MAR, .N0, .NU etc.

8 Planning of IQ8Wireless components

8.1 Planning information

When fire alarm systems are planned and installed e.g. in the Federal Republic of Germany, they must comply with certain standards and guidelines, including the following:

- DIN VDE 0100
- DIN 14675
- DIN VDE 0833
- DIN EN 54
- VdS Guidelines 2095, 2015, 2046, 2833 und 3448
- Local building authority conditions

In principle, these requirements and specifications should also be complied with in the planning of fire alarm systems outside the area of validity of these standards and guidelines.



Pay attention to the national and local requirements in accordance to the application area!

From DIN VDE 0833 – 2, section 6.2.5

- On any one transmission route a maximum of 128 detectors or devices may be connected, not including indirectly connected devices such as detector displays.

This means, per loop:

- Max. 123 IQ8Wireless bases (incl. IQ8Quad fire detectors without integrated alarm device) divided between 4 IQ8Wireless transponders (= 127 addresses) / 117 IQ8Wireless bases (incl. IQ8Quad fire detectors without integrated alarm device) divided between 10 IQ8Wireless transponders (= 127 addresses) and no further detectors/transponders on the loop.
- If extra detectors or transponders are operated on the loop, the corresponding number of wireless components is reduced.
- Each individual IQ8Wireless transponder must be powered via a separate protected supply line with an external +12 V DC voltage.
- If the power supply, e.g. from the FACP, is installed as fire area comprehensive, it must also be with E30 cable, alternatively the power supply can be via a DIN EN 54-4 defined and battery-buffered power unit in the same fire area as the IQ8Wireless transponder.
- Because an error (interruption, short circuit or error of a similar kind in a transmission route, e.g. defective information transfer) may occur on the line of the power supply, the rule of one IQ8Wireless transponder for fire detectors with IQ8Wireless base in a detection area applies.
- The IQ8Wireless transponder must be installed at least in the same fire section as the detector area of its assigned detector.



For further information refer to documentation of the IQ8Wireless devices.

8.2 System requirements

To use the IQ8Wireless components to the FACP the esserbus® or powered loop function is needed.

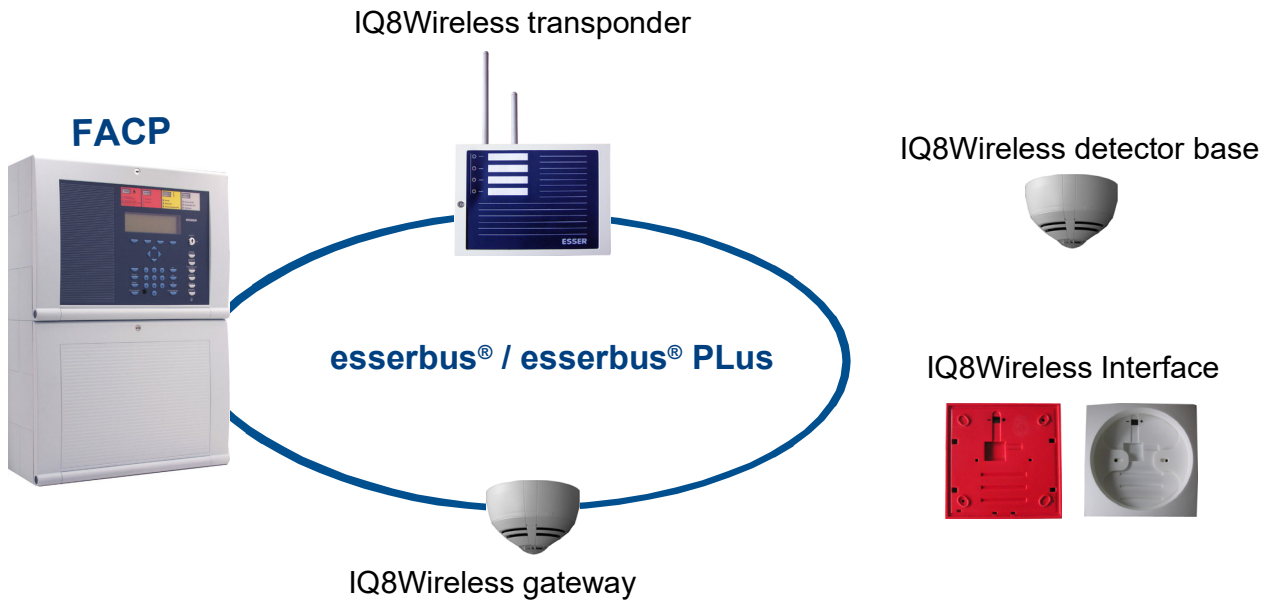

Fig. 37: IQ8Wireless components on the loop

8.3 Batteries for IQ8Wireless devices

The IQ8Wireless devices must be powered only with the recommended and approved lithium batteries (Part No. 805597).

The battery lifetime relates to the inserted fire alarm detector and the ambient temperature. In best case a battery lifetime up to 3 years may be achieved.

The charging status of the battery will be temporarily and automatically proofed. If the battery charging voltage drops under the required value an appropriate message is displayed at the Fire Alarm Control Panel. The batteries must be replaced within 14 days.



Observe the information on use of batteries in the "IQ8Wireless transponder for wall mounting" documentation (Part No. 798941.10).

9 Alarm devices

Alarm devices can be integrated in IQ8Quad automatic fire detectors (Section 5.3) or used as a stand-alone alarm device IQ8Alarm Plus on the esserbus® PPlus of ESSER fire alarm control panels. Conventional alarm devices (Section 9.2) are connected to the FACP via esserbus® transponders.

9.1 Alarm device IQ8Alarm Plus

The devices provide a synchronous visual alarm according to EN 54-23 and an audible alarm according to EN 54-3.

There is the option to use either the visual or audible alarm separately or to combine both together. The alarms can be configured to suit the intended application using the tools 8000 service and programming software. Up to 64 IQ8Alarm Plus can be connected to the esserbus® PPlus loop for ESSER fire alarm control panels. The flat base is included in the scope of delivery; alternatively, the IP base (806201 / 806202) can be used.

Features

- Device category: W-x-y/O-x-y in accordance with EN 54-23
- Visual alarm with configurable signal range in accordance with EN 54-23
- Variable load factors – for visual and/or acoustic systems, incl. voice
- Acoustic alarm devices according to EN 54-3 with 20 different programmable acoustic signals incl. DIN sound according to DIN 33404-3
- Acoustic voice signal devices according to EN 54-3 with 5 pre-programmed alarm texts in 5 languages
- Different text components are possible for alarms, evacuation and test alarms
- Simple programming thanks to a uniform programming interface for all alarm devices of the IQ8 system
- Power supply via esserbus® PPlus
- Up to 64 alarm devices per esserbus® PPlus
- Each alarm device with integrated isolator



Fig. 38: Alarm devices IQ8Alarm +

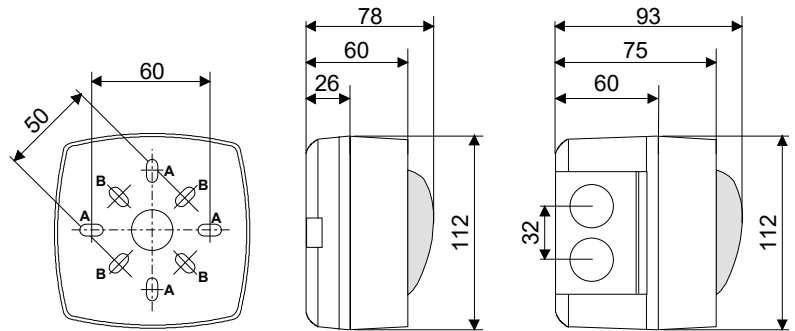

Fig. 39: Dimensions Dimensions (in mm)

System requirements

- FACP Compact, FACP IQ8Control, FACP FlexES Control (with current software versions)
- FACP with esserbus® PPlus functionality
- Service and programming software tools 8000

Alarm device	Alarm			Load factor			max. Number per loop
	Visual	Audible	Speech	Visual	Audible (incl. Speech)	Total	
807205R	---	✓	---	---	1,5-3,0	1,5-3,0	64
807205W	---	✓	---	---	1,5-3,0	1,5-3,0	64
807214RR	✓	---	---	3,0-7,9	---	3,0-7,9	32
807214WW	✓	---	---	3,0-7,9	---	3,0-7,9	32
807224RR	✓	✓	---	3,0-7,9	1,5-3,0	4,5-10,9	21
807224RW	✓	✓	---	3,0-7,9	1,5-3,0	4,5-10,9	21
807322R / -.SVxx	---	✓	✓	---	4,0	4,0	24
807322W / -.SVxx	---	✓	✓	---	4,0	4,0	24
807372RR.xx / .SVxx	✓	✓	✓	3,0-7,9	4,0	7,0-11,9	13
807372RW.xx / .SVxx	✓	✓	✓	3,0-7,9	4,0	7,0-11,9	13



- The load factors, FACP battery capacity, etc. can be determined using the configuration tool at www.esser-systems.com.
- The "Maxpector VAD Selection Guide" is available at www.esser.maxpector.com for online planning and configuration of the devices.

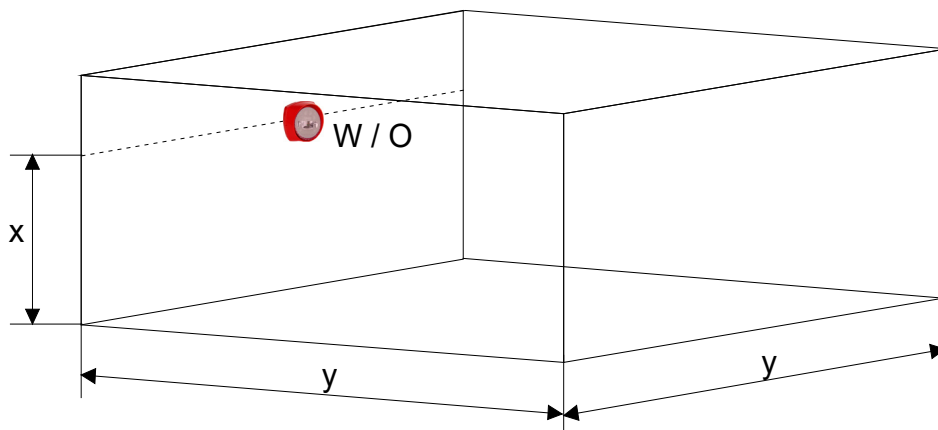

Fig. 40: W = wall mounting / signal range = height (x) x floor area (y x y)

Signal ranges → visual alarm (default setting)

Classification W-x-y	Class W: Wall / O: open	Installation height x [m]	Room width / depth y [m]	Light color r: red / w: white	Flash rate [Hz]	Effective intensity	Load factor (LF)	Max. Number of devices
W-2,4-5	W	2,4	5	r / w	0,5	6,6	3	32
W-3,2-7	W	3,2	7	r / w	0,5	13	6,2	15
W-3,6-8	W	3,6	8	r / w	0,5	17	7,9	12
OW-1,6-3,5	O	1,6	3,5	r / w	1	3,2	3	32
W2,4-5	W	2,4	5	r / w	1	6,6	5,5	17
W2,8-6	W	2,8	6	r / w	1	9,6	9,9	12



For further information on the sound pressure levels of the audible alarm, see Chap. 10.2.2 and 10.2.3.

Information on EN 54-23

In the event of a fire, visual alarm devices are used to warn and alert people in or near a building. This enables the people that have been warned to leave the danger zone safely and take appropriate action.

The advantage of a visual alarm is that – in areas with a high level of ambient noise or where people wear ear defenders when working – it is easily noticed and attracts the attention of the people that need to be alerted.

Visual and acoustic alarms can also be used in combination. This may be required to ensure that people who are hard of hearing are also warned/alerted appropriately.

Definitions

Visual alarm device (VAD):

A device that features a flashing light in order to visually alert people in the building to the fact that a fire has broken out.

Signal range:

Range in which the illumination level of (0.4 lm/m² [lx] to the normal of the light source) required by EN 54-23 is achieved.

Device categories (W; C; O):

Visual alarm devices (VAD) in accordance with EN 54-23 are divided into the following three device categories. There are different requirements for the signal range for each device category.

- Category **C** for ceiling-mounted alarm devices
These devices have a cylinder-shaped signal range, defined by C-x-y.
- Category **W** for wall-mounted alarm devices
These devices have a cube-shaped signal range, defined by W-x-y.
- Category **O** for alarm devices where the installation position is left open.
For these devices, the manufacturer specifies the geometric dimensions.

Light colour:

Visual alarm devices in accordance with EN 54-23 must emit a white or red light.

Flash frequency:

In accordance with EN 54-23, the flash frequency of a visual alarm device must be in the range [0.5...2 Hz].

Specifications

Operating voltage @ quiescent	: 14 V DC ... 42 V DC
Operating voltage @ alarm	: 25 V DC ... 42 V DC
Quiescent current @ 19 V DC	: 55 µA
Terminals	: max. 1,5 mm ² (AWG 30-14)
Storage temperature	: -25°C ... +75°C
Humidity	: ≤ 95 % rel. humidity (non-condensing)
Environmental class	: Type A (mainly for use in buildings)
Protection rating	: IP 43 (IP 21C acc. EN 54-3 / -23) IP 56 with base 806201 / 806202 (Do not use the base for acoustic alarm applications in compliance with EN 54-3)
Calotte	: Polycarbonate plastic, translucent / partially frosted
Housing	: Polycarbonate plastic
Colour	: red (similar to RAL 3020) or white (similar to RAL 9010)
Weight	: approx. 300 g (with back box)
Dimensions	: Ø 112 mm, H = 78 / 93 mm

Optical

Load factor	: 3 ^{*8} ... 7,9
Flash frequency	: 0,5 Hz ^{*8} / 1 Hz
Flash colour	: red or white (depending on type)
Mounting	: Wall
Signal range	: W-2,4-5 / 60 m ^{3*1} ... W-3,6-8 / 230 m ³
Application temperature	: -20°C ... +70°C
Specification	: EN 54-23 : 2010 / -17 : 2005
VdS approval	: G 215019
Declaration of Performance	: DoP-21429150413

Acoustic

Load factor	: 1,5 ^{*8} / 3 (807205xx/-24xx) 4 (807322xx / -72xx)
Sound pressure level @ 90° angle	: 89 dB (A) ^{*8} / 95 dB (A) (807205xx/-24xx) 95 dB (A) (807322xx/-72xx)
Application temperature	: -10°C ... +55°C
Specification	: EN 54-3 : 2001 / A1 : 2002 / A2 : 2006 / -17 : 2005
VdS approval	: G 218071
Declaration of Performance	: DoP-21430171215

Combination

Load factor	: Add values of optical and acoustic
VdS approval	: G 218031
Declaration of Performance	: DoP-21431171215

*8 Factory setting, configuration with service- and programming software tools 8000.

Wiring

The alarm device is connected directly to the esserbus® PLus. Further wiring is not necessary. Outward and return lines of the connection cable should not lie in the same cable or installation tube. Cable shielding of the connection protects the signal lines from the effects of disturbances.

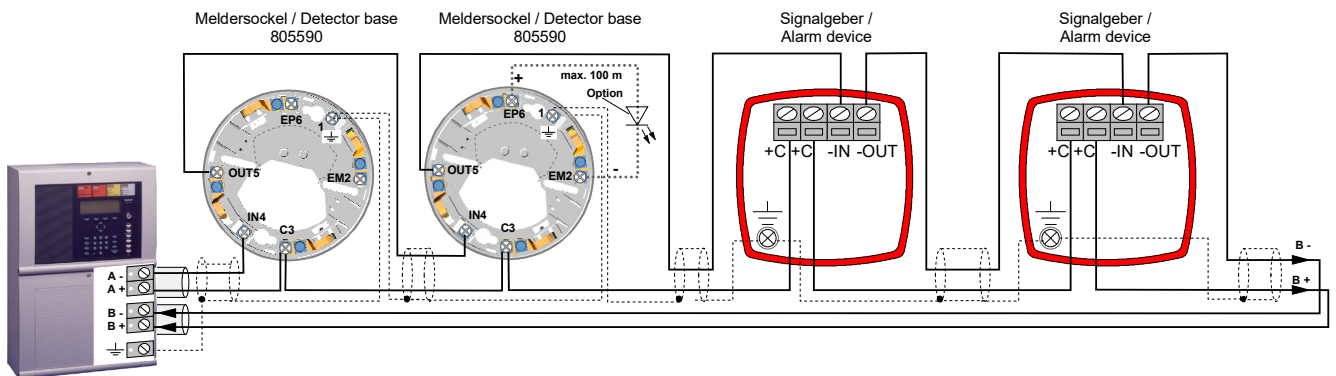

Fig. 41: Wiring example esserbus® PLus

Commissioning

The devices can be operated with the factory settings. Alternatively, the object-specific configuration is possible with the service and programming software tools 8000.

- With an audible alarm, up to four different audible signals incl. an alarm signal and an evacuation signal can be selected.
- With a visual alarm, it is possible to configure various signal ranges (with FACP FlexES Control and tools 8000 from V1.24).
- With voice functionality, voice outputs can also be configured for the audible and visual signals. The DIN tone is set as the default signal.

Depending on the device type used and the FACP programming, the range of audible signals, visual signals and voice outputs available may be limited. The load factor is depending on the selected configuration.

Special versions (Part No. 807xxx.SVxx)

The acoustic signals for alarms and evacuation are programmed for specific customers and objects at the factory and may therefore differ from the stated data.



The IQ8Alarm Plus alarm devices emit very bright flashes of light as a visual alarm. For configurations of very large signal ranges in particular, the flashes of light have a very high intensity level. The planner/fire alarm specialist must be aware of the dangers and instruct people accordingly in advance:

- Extremely bright LED are integrated into the alarm devices and are activated in the event of an alarm.
- Only work on the device when it is disconnected from the power supply.
- There is a risk of blindness – do not look directly into the light!

9.2 Conventional alarm device

There is a wide range of conventional alarm devices (visual, acoustic, combined) available in the Fire Alarm Technology product group catalogue. These devices are generally connected to ESSER fire alarm control panels via esserbus® transponders (refer to Section 12).

10 Development of audible alarm devices

Calculating the maximum number of alarm devices

The max. number alarm devices on the loop depends on the alarm device type and the length of the loop. The individual load factors of the bus devices must be determined and added onto this. The max. permissible total load factor of a loop is 96.



- The load factors, FACP battery capacity, etc. can be determined using the configuration tool at www.esser-systems.com.
- The "Maxpector VAD Selection Guide" is available at www.esser.maxpector.com for online planning and configuration of the devices.

Definition of sound pressure level

The sound pressure is the change in pressure which is generated by vibrating air molecules and subjectively perceived as volume. The human ear can hear within an effective sound pressure range of 0 to 120 dB at a frequency of 1000 Hz. This corresponds to a change in sound pressure of 20 N/m² (= Pa) or a factor of 1: 1,000,000 for the sound pressure level.

For the sake of simplification and to make the mathematical calculation easier, the logarithmic ratio of decibel (dB) was introduced to describe the sound pressure level. The table below shows the expected sound pressure levels in certain environments.

Environment	Sound pressure level (dB) ^{*9}
Residential area, at night	< 30
Individual offices	50
Open-plan offices	55-60
Warehouses with electric fork-lift trucks	65-70
Warehouses with diesel fork-lift trucks	70-75
Production halls with machines or very loud traffic noise	> 80
Jack hammer from a distance of 10 m	100
Siren from a distance of 10 m	110
Blows of a hammer in a blacksmiths shop from a distance of 1 m	130-150

^{*9} Example levels – the actual sound pressure levels may differ considerably from these values.

In practice, the following applies:

The sound pressure level emitted from audible alarm devices is given for a distance of 1 m from the source of the noise.

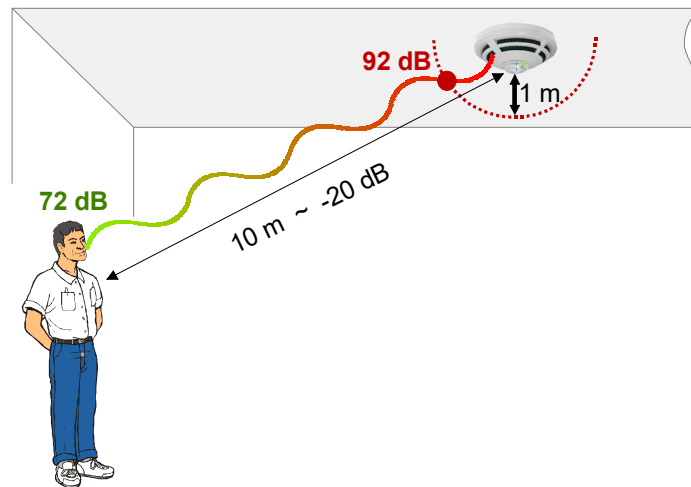

Fig. 42: Example

- Each time the distance from the source of the noise doubles, the sound pressure level reduces by 50 % (-6 dB).
- The 6 dB attenuation corresponds to a 50 % reduction in the sound pressure level.
- At a distance of 10 m from the source of the noise, the sound pressure level is reduced by 20 dB.
- An increase in the sound pressure level of 10 dB is perceived as a doubling of the volume (and vice versa).
- Differences of 3 dB are clearly audible – smaller differences in the sound pressure level are hardly noticed or only in a direct comparison.

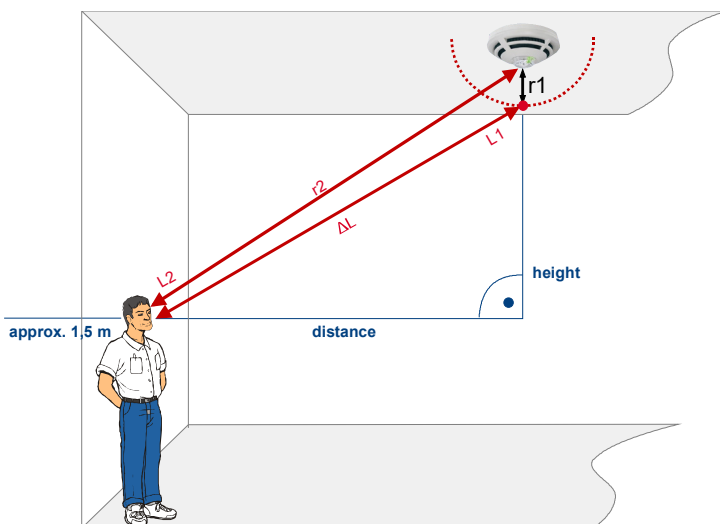

Fig. 43: Distance from the source of the noise

Calculating the sound level variation

Determining the sound level variation (ΔL) for sound pressure for acoustic alarm devices:

Unit	Value
$r_1 = 1 \text{ m}$ distance from the source of the noise	m
$r_2 =$ distance from the source of the noise	m
$\Delta L = L_2 - L_1$	dB

Level of the distant source:

$$L_2 = L_1 - 20 \times \log \left(\frac{r_1}{r_2} \right)$$

Sound level variation:

$$\Delta L = 20 \times \log \left(\frac{r_1}{r_2} \right)$$

Sound pressure level depending on the height of the ceiling and distance

Both the following tables provide a short guide for the expected sound pressure level in dB(A) taking account of the installation height (height) and the diagonal distance to the alarm device. The idealised values calculated here for the sound pressure level may, however, differ in practice. The reasons for this are the actual ambient conditions for the alarm and the type-dependent emission relationship.

Height [m]	Audible alarm device with 92 dB(A) / 1 m													Distance [m]
	0	1	2	3	4	5	6	7	8	9	10	11	12	
1	92													
2	86	85	83	81	79	77	76	75	74	73	72	71	70	
3	82	82	81	79	78	77	75	74	73	72	72	71	70	
4	80	80	79	78	77	76	75	73	73	72	71	71	70	
5	78	78	77	77	76	75	74	73	73	72	71	70	70	
6	76	76	76	75	75	74	73	73	72	71	71	70	69	Example values [dB], rounded up
7	75	75	75	74	74	73	73	72	71	71	70	70	69	
8	74	74	74	73	73	73	72	71	71	70	70	69	69	
9	73	73	73	72	72	72	71	71	70	70	69	69	68	
10	72	72	72	72	71	71	71	70	70	69	69	69	68	
11	71	71	71	71	71	70	70	70	69	69	69	68	68	
12	70	70	70	70	70	70	69	69	68	68	68	68	67	

Height [m]	Variation of the values for 85 dB(A) / 1m													Distance [m]
	0	1	2	3	4	5	6	7	8	9	10	11	12	
1	85													
2	79	78	76	74	72	70	69	68	67	66	65	64	63	Example values [dB], rounded up
3	75	75	74	72	71	70	68	67	66	65	65	64	63	
4	73	73	72	71	70	69	68	67	66	65	64	64	63	
5	71	71	70	70	69	68	67	66	66	65	64	63	63	
6	69	69	69	68	68	67	66	66	65	64	64	63	62	
7	68	68	68	67	67	66	66	65	64	64	63	63	62	
8	67	67	67	66	66	66	65	64	64	63	63	62	62	
9	66	66	66	65	65	65	64	64	63	63	62	62	61	
10	65	65	65	65	64	64	64	63	63	62	62	62	61	
11	64	64	64	64	64	63	63	63	62	62	62	61	61	
12	63	63	63	63	63	63	62	62	62	61	61	61	60	

10.1 Requirements

- The sound pressure level of the surroundings in which an audible alarm device is to be installed must be measured.
- The sound pressure level of the alarm device must be at least 65 dB and must be +10 dB higher at all locations than the sound pressure level that was measured for the surroundings. If necessary, several alarm devices may have to be planned.
- The sound pressure level of the signal tone (e.g. DIN tone) that is also going to be used later for alarm output in these surroundings, must also be measured.
- The signal tone must be clearly audible above the background noise. In case of similar frequencies, a different signal tone must be chosen and/or the alarm must be signalled with an additional optical alarm device.



In accordance with DIN 33404-3, an alarm signal and/or signal template for alarms (e.g. comprising signal tone + voice output) must always begin with the DIN tone. Then a voice message may be output.

- If possible, the audible alarm devices should be configured in control zones with a low control zone number. Low control zone numbers are activated quicker than high control zone numbers. Relay/LED outputs should have higher control zone numbers than alarm devices. As many loop activations as possible should be assigned to a control zone.
- Synchronisation is carried out at all esserbus® PPlus modules that are operated on a FACP.
- The gap between the synchronisation signals must be coordinated with the signal templates that were aggregated in the tools 8000 programming software (e.g. consisting of signal tone + voice output).
- If an alarm device is replaced with the device, all the activations are transferred. If an alarm device is replaced by a device from another zone, all activations are deleted, including the activations in the sectors.

10.2 Project planning information

10.2.1 IQ8Quad with integrated alarm devices

The sound pressure levels for IQ8Quad with integrated alarm devices and IQ8Alarm Plus in accordance with EN 54-3 are set out in the following tables.

Tone	Description	Sound pressure level (SPL) [dB(A)]											
		Horizontal angle [°]						Vertical angle [°]					
		15	45	75	105	135	165	15	45	75	105	135	165
2	Alternating signal tone, Frequency 800 Hz/970 Hz @ 2 Hz (based on FP 1063.1 Telecoms BS 5839 Pt1-Tone 1)	81	84	84	84	83	81	84	83	85	85	83	85
7	Continuous signal tone, Frequency 970 Hz (based on BS 5839 Pt1)	83	85	87	88	85	82	86	86	88	89	86	85
10	Alternating signal tone, Frequency 1200 ... 500 Hz @ 1 Hz, DIN tone in accordance with DIN 33404- 3 (factory setting)	84	84	88	88	83	83	84	84	86	87	83	82
11	Alternating signal tone, Frequency 554 Hz @/440 Hz (based on French fire sound)	81	84	87	89	84	80	81	84	85	86	83	80
12	Rising signal tone, Frequency 500 Hz ... 1200 Hz (based on NL - Slow Whoop)	86	86	88	87	85	84	85	86	87	87	85	84
13	Continuous signal tone, Frequency 485 Hz (based on US Horn)	77	74	80	82	77	76	79	75	82	82	78	78
14	Cyclic signal tone, Frequency 485 Hz (based on US Horn with Temporal Pattern)	75	72	78	82	77	73	78	75	82	82	78	81

10.2.2 IQ8Alarm Plus acoustics without voice

Sound pressure levels for acoustic alarm devices/voice signal devices for exclusive use of acoustics without voice

Tone	Description	Volume level	Load factor (LF) Alarm device	Load factor (LF) Voice signal device	Sound pressure level (SPL) [dB(A)]													
					Horizontal angle [°]						Vertical angle [°]							
					15	45	75	90	105	135	165	15	45	75	90	105	135	165
2	Alternating signal tone, Frequency 800 Hz/970 Hz @ 2 Hz	7	3,0	4	78	82	94	96	94	82	78	80	84	93	96	94	81	80
		4			77	81	94	96	95	81	77	79	83	93	96	94	80	80
		3	1,5		71	76	83	85	84	76	71	72	77	83	85	84	74	72
		0			53	57	65	67	65	57	53	54	58	65	67	65	56	54
7	Continuous signal tone, Frequency 970 Hz	7	3,0	4	77	82	94	96	94	82	77	79	84	93	96	94	81	80
		4			77	82	94	96	94	82	77	79	84	93	96	94	81	80
		3	1,5		71	78	81	85	82	78	70	69	80	80	85	81	77	70
		0			54	57	63	65	64	57	54	52	56	63	65	63	56	53
10	Alternating signal tone, Frequency 1200 ... 500 Hz @ 1 Hz, DIN tone in accordance with DIN 33404-3 (factory setting)	7	3,0	4	78	83	92	95	92	83	78	78	83	92	95	92	83	78
		4			78	83	92	95	92	83	78	78	83	92	95	92	83	78
		3	1,5		75	80	88	90	88	80	75	75	79	88	90	88	79	75
		0			56	61	69	71	69	62	57	56	61	69	71	69	61	56
11	Alternating signal tone, Frequency 554 Hz @ 440 Hz	7	3,0	4	75	80	88	89	88	80	75	76	79	88	89	88	79	75
		4			75	79	88	89	88	79	75	76	79	88	89	88	79	75
		3	1,5		75	79	87	88	87	79	75	75	79	87	88	87	78	75
		0			57	61	68	70	68	60	57	57	62	69	70	68	60	57
12	Rising signal tone, Frequency 500 Hz ... 1200 Hz	7	3,0	4	80	85	94	96	94	85	80	81	85	94	96	94	83	80
		4			78	83	93	95	93	83	78	78	83	93	95	93	81	78
		3	1,5		75	80	91	92	91	80	75	76	80	91	92	91	79	75
		0			57	62	69	71	69	61	57	57	62	69	71	69	61	57
13	Continuous signal tone, Frequency 485 Hz	7	3,0	4	76	76	84	87	84	77	75	76	76	85	87	84	76	75
		4			76	76	84	86	84	77	75	76	76	85	86	84	76	75
		3	1,5		76	76	83	86	83	77	75	76	76	84	86	84	76	75
		0			56	59	65	67	65	59	57	57	58	65	67	65	57	56
14	Cyclic signal tone, Frequency 485 Hz	7	3,0	4	76	76	84	86	84	77	75	75	76	84	86	84	76	75
		4			76	76	84	86	84	77	75	75	76	84	86	84	76	75
		3	1,5		76	76	83	86	83	77	75	75	76	84	86	84	76	75
		0			62	63	73	74	73	65	62	62	63	73	74	73	63	62



- The table contains the values of minimum sound pressure level and volumes depending on the direction of emission @ 1 m accordance to EN 54-3 (except 90° angle) in connection with the flat base.
- The values may be up to 0.5 dB lower owing to rounding.
- The values for 90° are informative and are not minimum specifications in accordance with EN 54-3.
- When using the IP base (806201, 806202) the values can deviate up to -3 dB.

10.2.3 IQ8Alarm Plus acoustics and voice

Sound pressure levels for acoustic voice signal devices for simultaneous use of acoustics and voice

Tone	Description	Volume level	Load factor (LF)	Sound pressure level (SPL) [dB(A)]															
				Horizontal angle [°]								Vertical angle [°]							
				15	45	75	90	105	135	165	15	45	75	90	105	135	165		
2	Alternating signal tone, Frequency 800 Hz/970 Hz @ 2 Hz	7	4	68	72	85	87	85	72	68	70	74	86	87	85	71	71		
		4		67	71	84	85	84	71	67	69	72	85	85	84	70	70		
		3		65	70	83	84	83	70	65	67	71	84	84	83	68	69		
		0		53	57	67	72	66	57	53	55	59	67	72	67	56	56		
7	Continuous signal tone, Frequency 970 Hz	7	4	68	73	86	87	86	73	68	69	74	87	87	87	72	72		
		4		65	70	84	85	84	70	65	67	72	85	85	84	69	69		
		3		64	69	83	84	83	69	64	66	71	84	84	83	68	68		
		0		53	57	65	72	65	57	53	54	58	65	72	66	56	55		
10	Alternating signal tone, Frequency 1200 to 500 Hz @ 1 Hz, DIN tone in accordance with DIN 33404-3 (factory setting)	7	4	71	76	87	88	87	76	71	72	76	87	88	87	76	71		
		4		70	75	86	87	86	75	70	71	75	86	87	86	75	71		
		3		69	75	85	86	85	75	69	70	74	85	86	85	74	70		
		0		55	60	71	72	71	60	55	56	60	71	72	71	60	56		
11	Alternating signal tone, Frequency 554 Hz @ 440 Hz	7	4	75	80	88	89	88	80	75	76	80	88	89	88	79	75		
		4		75	79	87	89	87	79	75	75	80	87	89	87	78	75		
		3		74	78	86	88	86	78	74	74	79	87	88	86	77	74		
		0		57	62	69	72	69	60	57	58	62	69	72	69	60	57		
12	Rising signal tone, Frequency 500 Hz ... 1200 Hz	7	4	71	76	87	88	87	76	71	72	76	87	88	87	74	71		
		4		70	75	86	87	86	75	70	71	75	86	87	86	74	70		
		3		69	74	85	86	85	74	69	70	74	85	86	85	73	69		
		0		55	60	71	72	71	60	55	56	60	70	72	71	59	56		
13	Continuous signal tone, Frequency 485 Hz	7	4	76	77	84	87	84	77	75	76	77	85	87	84	77	76		
		4		79	81	84	86	84	81	79	80	81	85	86	84	81	79		
		3		79	80	83	86	83	80	79	79	80	84	86	84	80	78		
		0		57	60	65	67	65	59	57	58	59	65	67	65	58	57		
14	Cyclic signal tone, Frequency 485 Hz	7	4	76	77	84	86	84	77	75	76	77	84	86	84	77	76		
		4		79	80	84	86	84	80	79	79	81	84	86	84	80	79		
		3		79	80	83	86	83	80	79	79	81	84	86	84	80	78		
		0		63	65	65	72	65	65	63	63	64	70	72	70	64	62		



- The table contains the values of minimum sound pressure level and volumes depending on the direction of emission @ 1 m accordance to EN 54-3 (except 90° angle) in connection with the flat base.
- The values may be up to 0.5 dB lower owing to rounding.
- The values for 90° are informative and are not minimum specifications in accordance with EN 54-3.
- When using the IP base (806201, 806202) the values can deviate up to -3 dB.

10.3 Commissioning

The commissioning and maintenance must only be performed by qualified technicians who are familiar with the fire alarm system.

The tools 8000 service and programming software is used for commissioning and performing maintenance on the devices. All functions and the status are checked cyclically and transmitted to the panel during the test operation of the FACP, where they are displayed in case of a fault.

Example:

1. Service PC with tools 8000 programming software to the FACP and set up panel configuration
2. Connect installed esserbus® PLus to the field bus and panel interfaces
3. Read bus device via wiring recognition
4. Assign IQ8Quad fire detector to the desired detector zone (e.g. zone 601/detector 1)
5. Define control zone number to activate the audible/optical alarm device
6. Create individual signal templates for audible alarm devices
7. Define audible devices as "local" in the properties dialogue box
8. Select and allot signal templates
9. Check and save customer data



- The customer data that was configured using the service and programming software tools 8000 must correspond to the actual configuration of the ESSER FACP and the external periphery.
- An IQ8Quad fire detector with voice output, such as the O²T/FSp multisensor detector (Part No. 802385), can also output a warning tone to alert.

Depending on the number of integrated alarm devices, optical and/or audible, it may be necessary to programme an additional one or two control zone numbers. The detector and control zone numbers must always relate to the valid number interval of the local fire alarm control panel. It is not possible to activate integrated alarm devices of the IQ8Quad fire detector across different panels.

Always observe the following system limits for assignment:

- a maximum of 127 devices in 127 detector zones can be installed on one loop
- a maximum of 32 devices can be aggregated into one detector zone
- it is not possible to operate a combination of manual call points MCP and automatic detectors
- esserbus® transponders always be aggregated into separate detector zones

In order to keep the total number of control zone numbers in complex security areas to a minimum, they can be aggregated into a single one. Observe that the same type of alarm devices may be aggregated in this way. In this way it is possible to activate all integrated audible and optical alarm devices with just one control zone number.

Up to 32 control zones can be aggregated into one single control zone for multiple use. Control zones of the esserbus® transponder cannot be aggregated into one zone.

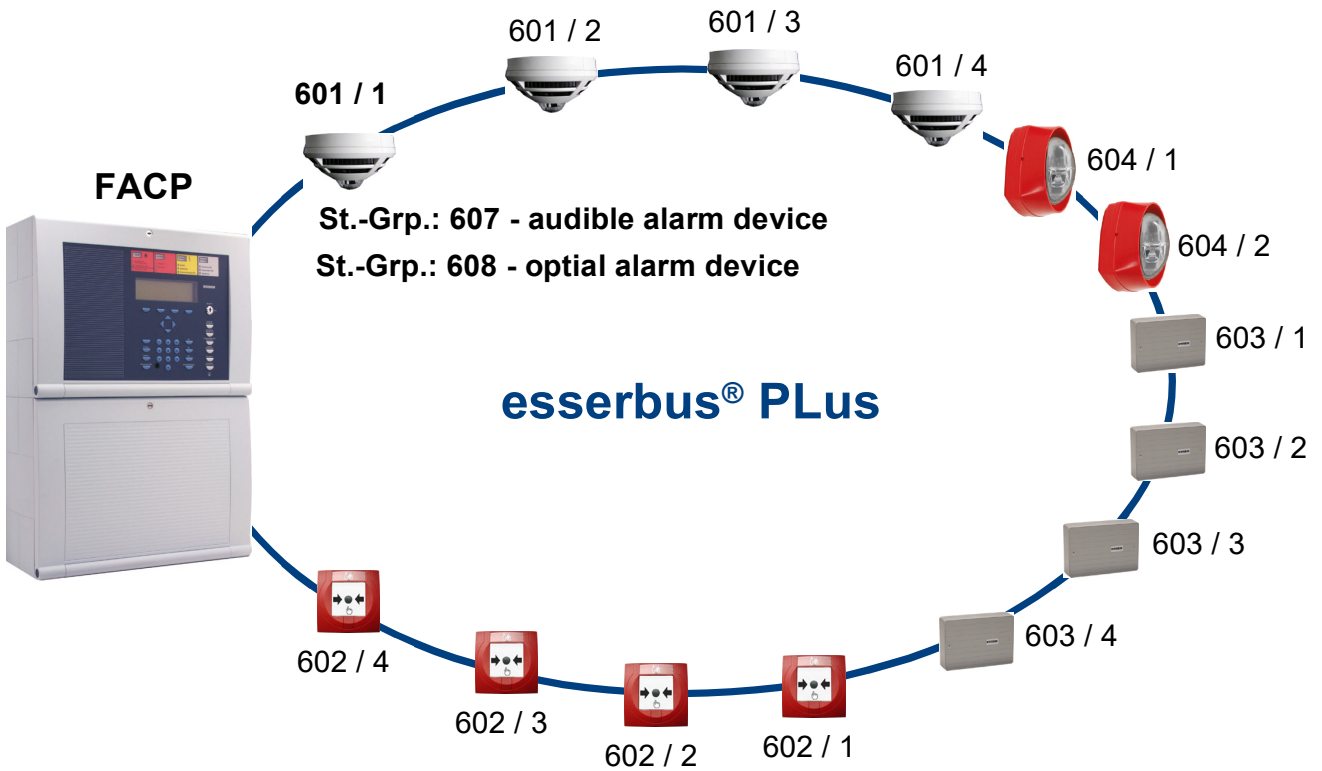





Fig. 44: Example control zones

Device	Description	Detector zone	Detector no.	Control zone	Alarm device
	IQ8Quad fire detector with alarm device	601	1	607 608	audible visual
			2 ... 4	---	
	IQ8Quad MCP	602	1 ... 4	---	
	esserbus® transponder	603	1 ... 4	---	
	IQ8 Alarm Plus	604	1 ... 2	---	

10.4 Creating a signal template

With the service and programming software tools 8000 provides all information on the signal templates. Up to 255 signal templates can be created and/or managed in a fire alarm control panel. The default signal template >Signal tone according to DIN 33404-3< is pre-set.

The output signal of a signal template can consist of up to four signal components. The combination of different signal components in connection with a different number of repeat frequencies also allows more complex tone/voice output signals to be created.

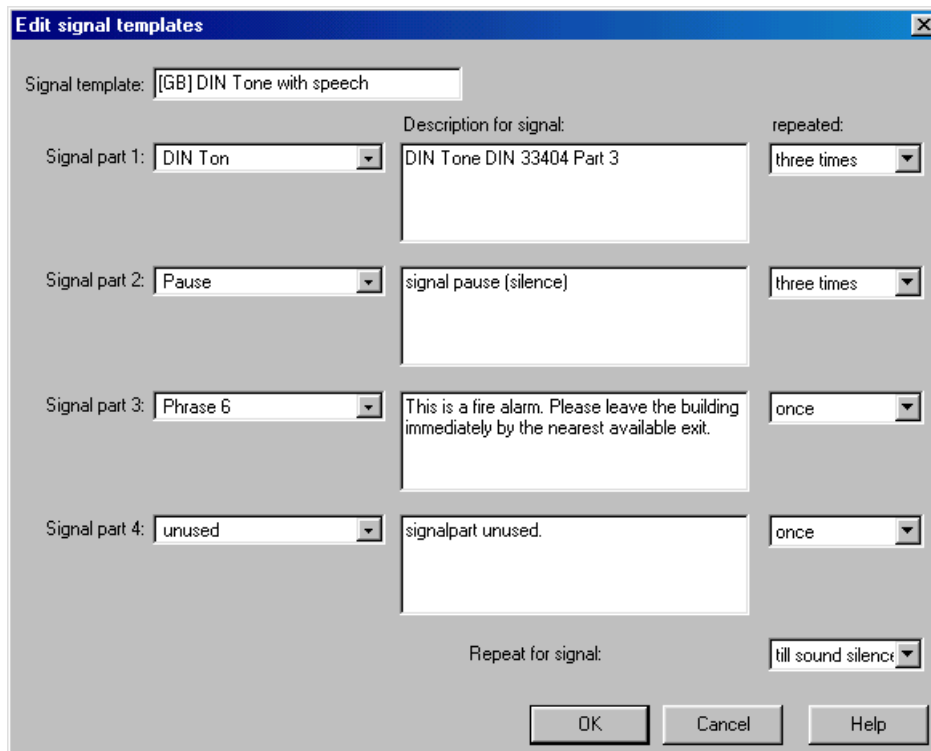

Fig. 45: Signal template [GB] DIN tone with speech

Example:

The signal template used here >[GB] DIN tone with speech< consists of three signal components.

For activation of the audible alarm device, control zone 607 is activated by detector no. 1 of detector zone 601 in case of the event >fire<.

Activation of control zone 608 remains active until the alarm device is deactivated by pushing the button >audible signal off< on the keyboard of the fire alarm control panel.

Example
Signal template = [GB] DIN tone with speech

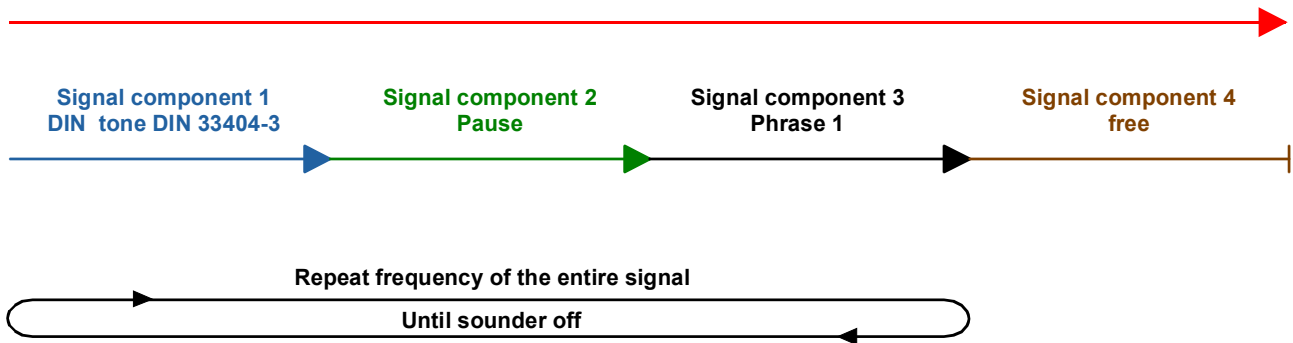























Fig. 46: Example signal template [GB] DIN tone with speech

Area of use	Description of signal template
	[D] DIN tone with voice output
	[GB] DIN tone with voice output























See the product group catalogue for a planning example for the esserbus® PLus.

10.4.1 Acoustic signals

Area of use	No*.	tools 8000**	Signal component	Signal description	Duration(s)
	1	0	School bell	School bell Complex signal sequence	1.00
	2	1	Tone 1 (GB)	FP 1063.1 Telecoms BS 5839 Pt1-Tone 1 Alternating signal tone, frequency 800/970 Hz @ 2 Hz 	4.00
	3	2	Tone 2 (GB)	FP 1063.1 Telecoms BS 5839 Pt1-Tone 2 Alternating signal tone, frequency 800/970 Hz @ 1 Hz 	4.00
	4	3	Tone 3 (GB)	FP 1063.1 Telecoms BS 5839 Pt1-Tone 3 Cyclic signal tone, frequency 970 Hz @ 1 Hz 	4.00
	5	4	Tone 4 (GB)	FP 1063.1 Telecoms BS 5839 Pt1-Tone 4 Cyclic signal tone, frequency 2850 Hz @ 1 Hz 	4.00
	6	5	Tone 5 (GB)	FP 1063.1 Telecoms BS 5839 Pt1-Tone 5 Cyclic signal tone, frequency 970 Hz 	3.75
	7	6	Tone 6 (GB)	FP 1063.1 Telecoms BS 5839 Pt1-Tone 6 Continuous signal tone, frequency 970 Hz 	4.00
	8	7	Tone 7 (GB)	FP 1063.1 Telecoms BS 5839 Pt1-Tone 7 Rising signal tone, frequency 800 ... 970 Hz @ 7 Hz 	4.00
	9	8	Tone 8 (GB)	FP 1063.1 Telecoms BS 5839 Pt1-Tone 8 Rising signal tone, frequency 800 ... 970 Hz @ 1 Hz 	4,00
	10	9	DIN Tone	DIN Ton gem. DIN 33404-3 Alternating signal tone, frequency 1200 ... 500 Hz @ 1 Hz 	4,00

* No. according VdS Certificate

**Signal reference according tools 8000 Software

Area of use	No.*	tools 8000**	Signal component	Signal description	Duration(s)
	11	10	Fire (France)	French fire sound Alternating signal tone, frequency 554 Hz @ / 440 Hz 	4,00
	12	11	Slow Whoop (NL)	NL - Slow Whoop Rising signal tone, frequency 500 Hz ... 1200 Hz 	4,00
	13	12	US Horn	US - Horn Continuous signal tone, frequency 485 Hz 	4,00
	14	13	US Horn (Pattern)	US - Horn with Temporal Pattern Cyclic signal tone, frequency 485 Hz 	4,00
	15	14	US March Time	US - March Time Alternating signal tone, frequency 485 Hz 	4,00
	16	15	US Slow Whoop	US - Slow Whoop Rising signal tone, frequency 500 Hz ... 1200 Hz 	4,50
	17	16	US Siren	US - Siren Rising signal tone, frequency 600 Hz ... 1200 Hz 	4,00
	18	17	US Hi/Lo	US - Hi/Lo Alternating signal tone, frequency 1000 Hz / 800 Hz 	4,00
	19	18	US NFPA Whoop	US - NFPA Whoop Rising signal tone, frequency 422 Hz ... 775 Hz 	3,55
	20	19	IMO GA-Signal (GA-Signal)	Intermittent 800 Hz (1,0 sec. ON; 1,0 sec. OFF: 7 times; 2,0 sec. ON: 2.0 sec. OFF; Repeat) 	18,0

* No. according VdS Certificate

**Signal reference according tools 8000 Software



Other acoustic signals and languages can be combined on a customer-specific basis. The programming is carried out in the factory. For detailed information, see the product group catalogue.

10.4.2 Voice (excerpt)

Area of use	Signal component	Signal description	Duration(s)
	Phrase 1	This is a fire alarm. Please leave the building immediately via the nearest escape route. The fire brigade has been notified.	6.44
	Phrase 2	Attention, attention! This is an emergency. Please leave the building via the nearest available exit.	5.70
	Phrase 3	Warning! An incident has been reported in the building. Please remain calm and await further instructions.	7.13
	Phrase 4	This is a test announcement.	1.90
	Phrase 5	The current alarm has been cancelled. We apologise for any inconvenience.	5.23
	Phrase 6	This is a fire alarm. Please leave the building immediately via the nearest available exit.	5.00
	Phrase 7	Attention please. This is an emergency. Please leave the building via the nearest available exit.	5.99
	Phrase 8	An incident has been reported in the building. Please await further instructions.	6.65
	Phrase 9	This is a test announcement. No action is required.	3.35
	Phrase 10	The emergency has now been cancelled. We apologise for any inconvenience.	4.40
	Phrase 11	Ceci est une alarme incendie, veuillez évacuer immédiatement les locaux par la sortie la plus proche.	7.53
	Phrase 12	Votre attention s'il vous plaît. Ceci est une alarme. Veuillez évacuer les locaux par la sortie la plus proche.	6.11

Area of use	Signal component	Signal description	Duration(s)
	Phrase 13	Un incident est signalé dans le bâtiment. Merci de garder votre calme et attendez les prochaines instructions.	6.66
	Phrase 14	Ceci est un test.	1.58
	Phrase 15	L'alarme est à présent annulée. Veuillez nous excuser pour le désagrément.	4.70
	Phrase 16	Esto es una alarma de incendio. Abandonen por favor el edificio inmediatamente por la salida de evacuación más cercana.	8.80
	Phrase 17	Atención. Esto es una emergencia. Por favor abandonen el edificio por la salida de evacuación más cercana.	6.97
	Phrase 18	Atención, se ha reportado un incidente en el edificio. Aguarden por favor otras instrucciones.	6.93
	Phrase 19	Esto es un mensaje de prueba. No se requiere ninguna acción.	4.71
	Phrase 20	La emergencia ha sido cancelada. Pedimos disculpas por las molestias causadas.	5.31
	Phrase 21	Attenzione. Allarme incendio. Abbandonare l'edificio tramite l'uscita di emergenza più vicina.	6.65
	Phrase 22	Attenzione. Allarme in corso. Vi preghiamo di recarvi presso l'uscita di emergenza più vicina.	6.51
	Phrase 23	Attenzione. E' stato rilevato un allarme. Ulteriori disposizioni vi verranno comunicate appena possibile.	7.16
	Phrase 24	Attenzione. E' in corso una prova di allarme. Non è richiesta alcuna azione.	5.20
	Phrase 25	Attenzione. Cessato allarme. La situazione di normalità è stata ripristinata.	6.71



Other acoustic signals and languages can be combined on a customer-specific basis. The programming is carried out in the factory. For detailed information, see the product group catalogue.

11 Maximum cable length and load factor

To assist with planning and project planning – appropriate to the removal of the FACP – the max. number of loop participants must be determined depending on the load factor and the line length and cross-section. The individual load factor (LF) of each device should also be included (see Specifications).

The max. permissible total load factor of a loop is 96 and must be calculated before installation / commissioning of the loop as the devices are supplied with power (including in the event of an alarm or when activated) via the loop.



There are various planning and project planning tools such as compatibility lists, load factor and emergency power calculations, order forms etc. available in the protected download area at www.esser-systems.com.



- Take note of max. possible loop length.
- Check bus device compatibility.
- max. permissible total load factor per loop = 96.
- Take note of max. permissible quantity of every device type.
- Max. 127 bus devices per loop.
- Determine and add on the individual load factors of the devices. The max. permitted loop lengths may differ considerably from the values in the table.
- The required emergency power bridging time and the corresponding battery capacity of the FACP must also be determined. Additional energy supply modules incl. emergency power supply may be required!
- Note the max. ambient temperature of the FACP!

Loop-participants and load factors

Fire detector IQ8Quad with integrated alarm devices		
Part No.	Description / function / device type	Load factor
802382	O/So optical smoke detector	2
802383	O ² T/F multisensor detector	2
802384	O ² T/So multisensor detector	2
802385.xx	O ² T/FSp multisensor detector	3
802386.xx	O ² T/Sp multisensor detector	3

Alarm device IQ8Alarm Plus							
Part No.	Alarm			Load factor			max. Number per loop
	Visual	Audible	Speech	Visual	Audible (incl. Speech)	Total	
807205R	---	✓	---	---	1,5-3,0	1,5-3,0	64
807205W	---	✓	---	---	1,5-3,0	1,5-3,0	64
807214RR	✓	---	---	3,0-7,9	---	3,0-7,9	32
807214WW	✓	---	---	3,0-7,9	---	3,0-7,9	32
807224RR	✓	✓	---	3,0-7,9	1,5-3,0	4,5-10,9	21
807224RW	✓	✓	---	3,0-7,9	1,5-3,0	4,5-10,9	21
807322R / -.SVxx	---	✓	✓	---	4,0	4,0	24
807322W / -.SVxx	---	✓	✓	---	4,0	4,0	24
807372RR.xx / .SVxx	✓	✓	✓	3,0-7,9	4,0	7,0-11,9	13
807372RW.xx / .SVxx	✓	✓	✓	3,0-7,9	4,0	7,0-11,9	13



The load factors, FACP battery capacity, etc. can be determined using the configuration tool at www.esser-systems.com.

12 esserbus[®] transponder

The esserbus[®] transponders enable conventional technology and the esserbus[®] to be connected. They are used for different activations.

E.g. "alarm transponder" which is used for both the connection of non-addressable detectors (point-type detectors, manual detectors and special detectors) as well as for the operation of conventional alarm signaling devices (signaling devices, signal flasher and combination alarm signaling devices). The planning of the alarm devices that can be connected is carried out via a calculation tool, which is part of the tools 8000 service and programming software.

Monitoring of the lines in accordance with the latest standards is ensured via "EOL modules" (end-of-line modules).

The IQ8FCT XS or LP can be used as a fire control transponder (FCT) for controlling and monitoring fire protection equipment such as fire dampers, and as a technical alarm module (TAL) for monitoring an external switching contact.

These modules with low power consumption are for interfacing to other disciplines which are not a part of the fire detection system itself. Thanks to their intelligent concept they significantly expand the range of monitoring and control functions as part of the building management.

Part No.	Description
808623	esserbus [®] alarm transponder
808623.10	esserbus [®] transponder for UniVario
808623.40	esserbus [®] transponder SD for Special detector
808610.10	esserbus [®] transponder 12 relays
808611.10	esserbus [®] transponder 32 LED
808613.30	esserbus [®] transponder Standard Interface Extinguishing (SIE)
808619.10	esserbus [®] FSA transponder for fire doors
808606	esserbus [®] transponder IQ8FCT XS
808621	esserbus [®] transponder IQ8FCT LP, 230 V AC
804867	esserbus [®] transponder IQ8FCT
804868	Technical alarm device IQ8TAL

Part No.	Accessories
808624	End-of-line element EOL-O - for alarm devices
808626	End-of-line element EOL-I - detector zone termination
808626.10	End-of-line element EOL-UV
804870	Alarm and monitoring module for IQ8TAM, IQ8TAL, IQ8FCT XS and LP
788612	Loop isolator
788603.10	Module housing for top-hat mounting rail
788600	Housing surface mount, grey
788650.10	Housing surface mount, white
788601	Housing flush mount, grey
788651.10	Housing flush mount, white
781336	DC/DC converter Output voltage 12 V DC
M200SMB	Module housing surface mounting
SMB6-V0	Module housing surface mounting of up to 6 esserbus [®] transponder IQ8FCT XS

12.1 esserbus® alarm transponder (Part No. 808623)

As a loop device on the loop, the esserbus® transponder enables the connection of automatic standard fire detectors, manual call points (MCP) without addressing, and third-party detectors. In addition, two programmable relay outputs are also available.

Monitoring via the EOL terminating devices (Part No. 808624 / 808626) is required for the connection of fire detectors and for the controlling of alarm signaling devices. The enclosed resistors can be used to connect the floating contacts.

The planning of the alarm devices that can be connected is carried out via a calculation tool, which is part of the tools 8000 service and programming software.

The esserbus® alarm transponder requires an external voltage supply. These can be programmed in monitored mode. An optional Voltage Converter (Part No. 781336) is also required for 12 V DC operation.

According to DIN VDE 0833-2, fire detectors from max. one detection area and alarm devices and tools from one alarm area must be connected to one alarm transponder.

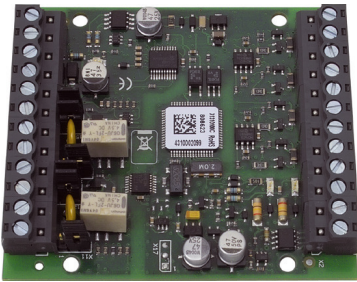

Features

- 4 detector zone inputs
- Conventional connection of standard fire detectors and signaling devices
- Loop monitoring in compliance with EN 54-13
- Integrated loop isolator
- 2 programmable relay outputs
- Programmable reset relay function

Fig. 47: esserbus® alarm transponder

Specifications

Loop

Rated voltage	: 8 V DC ... 42 V DC
Rated current	: approx. 90 µA @ 19 V DC

External power supply

Operating voltage	: 10 V DC ... 28 V DC
Current consumption	: max. 120 mA @ 12 V DC
Quiescent current	: approx. 12 mA @ 12 V DC

Inputs

Current consumption	: max. 25 mA @ 9 V DC
Length of connection cable	: max. 1.000 m
Monitoring	: EOL-I or 10 kΩ / ±40%

Relays

Contact rating	: max. 30 V DC / 1 A
Monitoring relay	: EOL-O or 10 kΩ / ±40%
Connection terminals	: max. 1,5 mm ² (AWG 30-14)
Ambient temperature	: -10 °C ... +50 °C
Storage temperature	: -25 °C ... +75 °C
Rel. humidity	: ≤ 95% (no condensation)
Protection rating	: IP 40 (with housing)
Weight	: approx. 28 g
Dimensions (w x h x d)	: 82 x 72 x 20 (mm)
Specification	: EN 54-17 : 2005
VdS approval	: G 210020
Declaration of Performance	: DoP-21057130701



For further information and accessories refer to product catalogue and documentation of the devices.

12.2 esserbus® transponder for UniVario (Part No. 808623.10)

The transponder enables the connection of max. 2 industrial detectors of the UniVario product family as components of the loop.

These detectors are supplied with energy via the 9 V DC group voltage input. For meeting the standard requirements of monitoring, an EOL-UV terminal element is connected to the detector base of the UniVario detector. Der Koppler benötigt eine externe Spannungsversorgung. An optional Voltage Converter (Part No. 781336) is also required for 12 V DC operation.

Furthermore, two optionally monitored relay outputs are available.



Features

- Suitable for connecting industrial detectors of the UniVario product family
- Integrated loop isolator
- Loop monitoring acc. EN 54-13

Fig. 48: esserbus® transponder for UniVario

Specifications

Loop

Rated voltage : 8 V DC ... 42 V DC
 Current consumption : approx. 90 µA @ 19 V DC

External power supply

Operating voltage : 10 V DC ... 28 V DC
 Current consumption : max. 120 mA @ 12 V DC
 Quiescent current : approx. 12 mA @ 12 V DC

Input

Current consumption : max. 25 mA @ 9 V DC
 Length of connection cable : max. 100 m
 Monitoring : EOL-UV

Relays

Contact rating : 30 V DC / 20 mA
 Monitoring : EOL-O or 10 kΩ / ±40%
 Ambient temperature : -10 °C ... +50 °C
 Storage temperature : -25 °C ... +75 °C
 Rel. humidity : ≤ 95% (no condensation)
 Protection rating : IP 40 (with housing)
 Weight : approx. 28 g
 Dimensions (w x h x d) : 82 x 72 x 20 (mm)
 Specification : EN 54 - 17 : 2005 / - 18 : 2005
 VdS approval : G 210020
 Declaration of Performance (808623.10) : DoP-20611130701
 (808623.10.NU) : DoP-20947130701



For further information and accessories refer to product catalogue and documentation of the devices.

12.3 esserbus® transponder Special detector (SD) (Part No. 808623.40)

To connect special detectors and related reset functions with pre-alarm, fault and alarm assessment. The transponder can be adapted to the different reset behaviours of the connected special detectors. The inputs and outputs of the transponder can be connected with one another in such a way that switching on / resetting a signalling input leads to short-term activation of the special detector's reset input. In order to support various special detectors, the transponder's inputs can be programmed with a suppression time of up to 255 seconds when resetting.



Features

- 4 detector zone inputs
- Conventional connection of special detectors
- 2 programmable relay outputs for resetting the special detector with flexible reset times
- Integrated loop isolator
- Loop monitoring acc. EN 54-13

Fig. 49: esserbus® transponder for UniVario



The transponder can solely be operated with the abovementioned properties on the FlexES Control FACP. On the IQ8Control and Compact FACP, the transponder behaves like an alarm transponder (Part No. 808623).

Specifications

Loop

Rated voltage	: 8 V DC ... 42 V DC
Rated current	: approx. 90 µA @ 19 V DC

External power supply

Operating voltage	: 10 V DC ... 28 V DC
Current consumption	: max. 120 mA @ 12 V DC
Quiescent current	: approx. 12 mA @ 12 V DC

Inputs

Current consumption	: max. 25 mA @ 9 V DC
Length of connection cable	: max. 1.000 m
Monitoring	: EOL-I or 10 kΩ / ±40%

Relays

Contact rating	: max. 30 V DC / 1 A
monitoring relay	: EOL-O or 10 kΩ / ±40%
Connection terminals	: max. 1,5 mm ² (AWG 30-14)
Ambient temperature	: -10 °C ... +50 °C
Storage temperature	: -25 °C ... +75 °C
Rel. humidity	: ≤ 95% (no condensation)
Protection rating	: IP 40 (with housing)
Weight:	: approx. 28 g
Dimensions (w x h x d)	: 82 x 72 x 20 (mm)
Specification	: EN 54-17 : 2005
VdS approval	: G 210020
Declaration of Performance	: DoP-21057130701



For further information and accessories refer to product catalogue and documentation of the devices.

12.4 esserbus® transponder 12 relays (Part No. 808610.10)

The esserbus® transponder works as a loop device on the loop, it is possible to expand the number of outputs per ESSER FACP.

In 'potential-free' mode, no external switching voltage is required for relays K1 to K11.

In 'monitored' mode, the relays can be switched with an external power supply (UBext.). The monitoring of UBext. enables a fault warning on the FACP if the permissible tolerance limits are not met. 'Monitored' mode is configured using the service and programming software tools 8000.

The contact behaviour (NC / NO functionality) of relay contacts K1 to K11 can be individually programmed in the customer data. The functionality as a common fault relay is permanently assigned to relay 12 (NO contact).

The maximum line length from the transponder to the external tool is up to 1000 m. There is also the option of operating the transponder with the loop isolator (Part No. 788612).

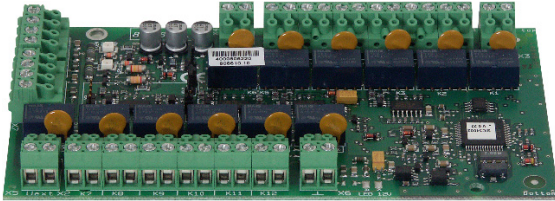

Features

- Only one loop address is needed per transponder
- Max. 100 transponders per FACP
- Max. 32 transponders per loop
- Max. 32 transponders per detector zone

Fig. 50: esserbus® transponder 12 relays

Specifications

Loop

Rated voltage	: 8 V DC ... 42 V DC
Rated current	: approx. 100 µA @ 19 V DC

External supply

Operating voltage	: 10 V DC ... 28 V DC
Current consumption	: approx. 3 mA @ 12 V DC

Relays

Contact rating	: 30 V DC / 1 A (max. 3 A per transponder)
Contact type K1 to K11	: NO/NC contact
Contact type K12	: Common fault relay (NO contact)

Ambient temperature	: -10 °C ... +50 °C
Storage temperature	: -25 °C ... +75 °C
Humidity	: ≤ 95% rel. humidity (no condensation)
Protection rating	: IP 40 (with housing)
Weight	: approx. 110 g
Dimensions (w x h x d)	: 150 x 82 x 20 (mm)
Specification	: EN 54 – 17:2005/-18:2005
VdS approval	: G 206044
Declaration of Performance	: DoP-20611130701



For further information and accessories refer to product catalogue and documentation of the devices.

12.5 esserbus® transponder 32 LED (Part No.808611.10)

As a loop device on the loop, the esserbus® transponder enables the implementation of 32 outputs for direct LED activation (e.g. for a panel). The outputs can be used with positive or negative switching. Service and programming software tools 8000 is used for configuration.

The esserbus® transponder requires an external power supply. The external power supply can be programmed in monitored mode.

The maximum line length from the transponder to the external device is up to 100 m.

There is also the option of operating the transponder with the loop isolator (Part No. 788612).

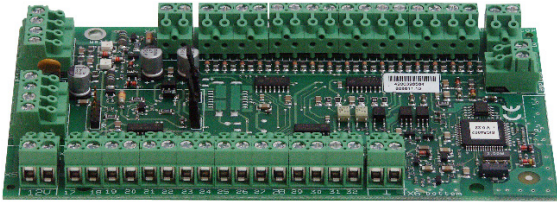

Features

- Only one loop address is needed per transponder
- Max. 100 transponders per FACP
- Max. 32 transponders per loop
- Max. 32 transponders per detector zone

Fig. 51: esserbus® transponder 32 LED



Monitored control acc. to EN 54 is not possible. Operation on the FlexES Control or Compact FACP only in conjunction with the power converter (Part No. 781336).

Specifications

Loop

Rated voltage	: 8 V DC ... 42 V DC
Rated current	: approx. 50 µA @ 19 V DC

External power supply

Operating voltage	: 10 V DC ... 15 V DC
Quiescent Current	: approx. 3 mA @ 12 V DC

LED outputs

Properties	: 12 V DC / 10 mA
Switching mode	: plus/minus switching
Max. length of connection cable	: max. 100 m (Ri = 1 kΩ) : max. 3 m (Ri = 0 Ω)
Ambient temperature	: -10 °C ... +50 °C
Storage temperature	: -25 °C ... +75 °C
Humidity	: ≤ 95 % rel. humidity (no condensation)
Protection rating	: IP 40 (with housing)
Weight	: approx. 95 g
Dimensions (w x h x d)	: 150 x 82 x 20 (mm)
Specification	: EN 54 - 17:2005/-18:2005
VdS approval	: G 206044
Declaration of Performance	: DoP-20611130701



For further information and accessories refer to product catalogue and documentation of the devices.

12.6 esserbus® transponder SIE (Part No. 808613.30)

The esserbus® transponder Standard Interface Extinguishing (SIE) allows for the connection of extinguishing agent control systems/extinguishing systems to the fire alarm system.

An external power supply of 12 V DC or 24 V DC can be connected to the esserbus® transponder.

For 12 V DC operation, the power converter (Part No. 781336) is required. The external power supply can be configured to be monitored using the service and programming software tools 8000.

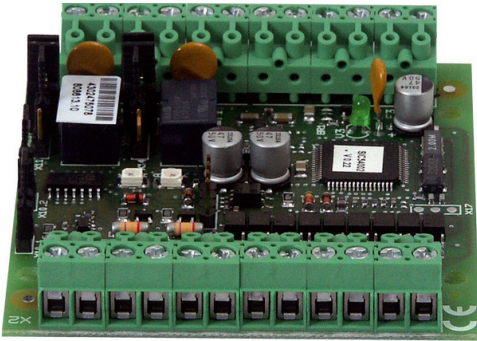

Features

- Only one loop address is needed per transponder
- Max. 100 transponders per FACP
- Max. 31 transponders per loop
- Max. 32 transponders per detector zone

Fig. 52: esserbus®-Koppler SIE

Specifications

Loop

Rated voltage	: 19 V DC, max. 42 V DC
Current consumption	: approx. 250 µA @ 19 V DC

External power supply

Operating voltage	: 10 V DC ... 28 V DC
Current consumption	: max. 120 mA @ 12 V DC
Quiescent current	: approx. 10 mA @ 12 V DC

Zone inputs

Rated voltage	: 9 V DC
Current consumption	: max. 25 mA
Length of connection cable	: max. 1.000 m

Relays

Contact rating	: 30 V DC / 1 A
Ambient temperature	: -10 °C ... +50 °C
Storage temperature	: -25 °C ... +75 °C
Humidity	: ≤ 95% rel. humidity (no condensation)
Protection rating	: IP 40 (in housing)
Weight	: approx. 28 g
Dimensions (w x h x d)	: 82 x 72 x 20 (mm)
Specification	: EN 54-17:2005 / -18:2005
VdS approval	: G 206042
Declaration of Performance	: DoP-20614130701



For further information and accessories refer to product catalogue and documentation of the devices.

12.7 esserbus® transponder IQ8FCT XS (Part No. 808606)

The IQ8FCT XS can be used as a fire control transponder (FCT) for controlling and monitoring fire protection equipment* such as fire dampers, as well as a technical alarm module (TAL) for monitoring an external switching contact. The transponder is a loop device and therefore has an integrated loop isolator, a contact input and a potential-free relay output. For external indication, a parallel detector indicator (Part No. 781804, 781814 or 801824) can be connected (max. loop length 100 m). The transponder does not require a separate power supply. To monitor the contact, the alarm and monitoring module (Part No. 804870) or an external resistance combination can be used. The max. loop length to the contact is 500 m.

* Observe the local and regional requirements/regulations for the activation of fire protection equipment.



Features

- Max. 127 transponders per ring loop
- One contact input and one potential-free relay output
- Connection for a parallel detector indicator
- Power supply via fieldbus
- Programmable impulse control of the relay output
- Programmable runtime monitoring for activation of fire dampers
- Programmable relay output NO/NC
- Programmable impulse length for relay activation (for time-limited activation)
- Feedback input for monitoring fire control systems
- Integrated loop isolator
- Pluggable connecting terminals
- Installation on top-hat rails or in surface mount housing (Part No. M200SMB/SMB6-V0)

Fig. 53: esserbus® transponder IQ8FCT XS



In order to control the fire protection device in compliance with the relevant standards, the IQ8FCT should be installed right next to or inside the control device.

Specifications

Loop

- Nominal voltage	:	14 V DC ... 42 V DC
- Quiescent current	:	approx. 45 µA @ 19 V DC
- Alarm current	:	approx. 9 mA @ 19 V DC, pulsed
Number	:	max. 127 piece per loop
Alarm indicator	:	red LED
Operation indicator	:	green LED
Connection terminals	:	max. 2,5 mm ² (AWG 26-14)
Application temperature	:	-20 °C ... +70 °C
Storage temperature	:	-30 °C ... +75 °C
Humidity	:	≤ 95 % rel. humidity (non-condensing)
Protection rating	:	IP 30 / IP 50 (with M200E-SMB-KO)
Housing	:	PC/ASA plastic
Colour	:	grey (similar RAL 7035)
Weight	:	approx. 90 g

Dimensions (w x h x d)

- IQ8FCT XS	:	90 x 93 x 23 (mm)
- M200SMB	:	144 x 134 x 50 (mm)
Specification	:	EN 54-17 : 2005 / -18 : 2005
VdS approval	:	G 209138
Declaration of Performance	:	DoP-20792130701



For further information and accessories refer to product catalogue and documentation of the devices.

12.8 esserbus® transponder IQ8FCT LP, 230 V AC (Part No. 808621)

The IQ8FCT LP can be used as FCT (fire control transponder) to control and monitor external fire protection devices like fire dampers or as a technical alarm module (TAL) to monitor an external contact *.

The transponder is a loop device and therefore has an integrated loop isolator, a contact input and a potential-free relay output, which can be used to directly switch 230 V AC / 16 A. The transponder is powered by the field bus and does not require external voltage supply.

To monitor the contact, the alarm and monitoring module (Part No. 804870) or an external resistance combination can be used. The max. loop length to the contact is 500 m. The IQ8FCT LP is delivered in a robust IP 65 protected surface mount housing.

* Zur Ansteuerung von Brandschutzeinrichtungen die lokalen und regionalen Anforderungen / Vorschriften beachten.



Features

- Intelligent fire control systems via programmable logics of the inputs and outputs of the FCT
- Programmable runtime monitoring for activation of fire dampers
- Optional impulse activations of the relay can be programmed with selectable impulse lengths
- Programmable fail-safe settings of the relay for protection against failure and disruption to the fire alarm system
- Feedback contact for monitoring the error-free function of the fire control system
- Switching capacity up to 230 V AC/16 A
- Max. 127 transponders per loop
- Power supply via fieldbus
- Integrated loop isolator
- Robust IP 65-protected surface-mount housing

Fig. 54: esserbus® transponder IQ8FCT LP, 230 V AC



In order to control the fire protection equipment in compliance with the relevant standards, the IQ8FCT should be installed right next to or inside the control device.

Specifications

Loop

- Nominal voltage	: 14 V DC ... 42 V DC
- Quiescent current	: approx. 45 µA @ 19 V DC
- Alarm current	: approx. 9 mA @ 19 V DC, pulsed
- Number	: max. 127 piece per loop
Alarm display	: red LED
Operating display	: green LED
Relay contact rating	: 230 V AC / 30 V DC, 16 A resistive, 8 A induct load

Terminals

- Contact input / loop	: max. 2,5 mm ² (AWG 26-14)
- Relay contact / power supply	: max. 6 mm ² (AWG 30-10)
Ambient temperature	: -20 °C ... +70 °C
Storage temperature	: -30 °C ... +75 °C
Humidity	: ≤ 95 % (without condensing)
Protection rating	: IP 65
Housing	: PP plastic
Colour	: grey (similar to RAL 7035)
Weight	: approx. 250 g
Dimensions (w x h x d)	: 150 x 116 x 67 (mm)
Specification	: EN 54-17 : 2005 / -18 : 2005
VdS approval	: G 209138
Declaration of Performance	: DoP-20792130701



For further information and accessories refer to product catalogue and documentation of the devices.

12.9 Technical Alarm Module IQ8TAL (Part No. 804868)

The technical alarm module is a loop device that enables technical alarms to be detected and forwarded. The IQ8TAL is equipped with an integrated loop isolator, a contact input and a relay output. The integrated relay can be optionally configured as a normally-closed contact or as a normally-open contact. The IQ8TAL does not need a separate voltage supply.

In order to increase the IP protection class, the optional IP 55 protection kit (Part No. 704965) can be used. The functionality of the IQ8TAL can be tested with the included key and the alarm status can be reset directly at the device.



Features

- One contact input and one floating relay output
- Power supply via fieldbus
- Test and reset function
- Optional higher IP55 protection
- Programmable inverse monitoring functionality of the contact input (1 kOhm quiescent / 10 kOhm fire)
- Integrated loop isolator
- Up to 127 IQ8TAL per loop

Fig. 55: IQ8TAL Technical Alarm Module

Specifications

Power supply	: 8 V DC ... 42 V DC
Quiescent current	: approx. 45 µA @ 19 V DC
Alarm current	: approx. 9 mA @ 19 V DC, pulsed
No. of call points	: max. 127 TAL per loop
Alarm indicator	: red LED
Operation indicator	: green LED
Connection terminals	: max. 1,5 mm ² (AWG 30-14)
Application temperature	: -20 °C ... +70 °C
Storage temperature	: -30 °C ... +75 °C
Protection rating	: IP 43 (in housing) : IP 55 (with option 704965)
Housing	: PC/ASA plastic
Colour	: blue (similar RAL 5015)
Weight	: approx. 110 g
Housing dimensions (w x h x d)	: 88 x 88 x 27 (mm)
Dimensions with back box	: 88 x 88 x 63 (mm)
Specification	: EN 54-17 : 2005 / -18 : 2005
VdS approval	: G 209138
Declaration of Performance	: DoP-20792130701



For further information and accessories refer to product catalogue and documentation of the devices.

12.10 IQ8FCT (Part No. 804867)

Like the IQ8TAL, the IQ8FCT is an esserbus® transponder with a contact input and a potential-free relay output. For controlling and monitoring fire control systems, such as fire dampers. Programmable runtime monitoring is used to check that fire dampers are closed at the correct time and that this is transmitted to the FACP.



Fig. 56: IQ8FCT

Features

- Can be configured using service and programming software tools 8000
- Impulsive triggering of relay output
- Runtime monitoring for activation of fire dampers
- Relay output NO / NC
- Impulse length for relay activation (for time-limited activation)
- Feedback input for monitoring fire control systems

Specifications

Power supply	:	8 V DC ... 42 V DC
Quiescent current	:	approx. 45 µA @ 19 V DC
Alarm current	:	approx. 9 mA @ 19 V DC, pulsed
No. of call points	:	max. 127 IQ8FCT per loop
Alarm indicator	:	red LED and yellow tab
Operation indicator	:	green LED
Connection terminals	:	max. 1,5 mm ² (AWG 30-14)
Application temperature	:	-20 °C ... +70 °C
Storage temperature	:	-30 °C ... +75 °C
Protection rating	:	IP 43 (in housing) IP 55 (with option)
Housing	:	PC/ASA plastic
Colour	:	grey (similar RAL 7035)
Weight	:	approx. 110 g
Housing dimensions (w x h x d)	:	88 x 88 x 27 (mm)
Dimensions with back box	:	88 x 88 x 63 (mm)
Specification	:	EN 54-17 : 2005 / -18 : 2005
VdS approval	:	G 20138
Declaration of Performance	:	DoP-20792130701



For further information and accessories refer to product catalogue and documentation of the devices.

Novar GmbH a Honeywell Company

Forumstraße 30

41468 Neuss, Germany

Telefon: +49 2131 40615-600

Telefax: +49 2131 40615-606

Internet: www.esser-systems.com

E-Mail: info@esser-systems.com

ESSER

by Honeywell

Technical changes reserved!

© 2020 Honeywell International Inc.